

**THE EFFECT OF HIV-1 INFECTION, HIV/HBV, HIV/HCV
CO INFECTIONS ON LEUKOCYTES IN THE PRESENCE
OF ACTIVATED RANTES G 28**

CATHERINE MEDZA TSUMA

MASTER OF SCIENCE

(Biotechnology)

**JOMO KENYATTA UNIVERSITY OF
AGRICULTURE AND TECHNOLOGY**

2016

The effect of HIV-1 infection, HIV/HBV, HIV/HCV co infections on leukocytes in the presence of activated RANTES G 28.

Catherine Medza Tsuma

Thesis submitted in partial fulfillment for the degree of Master of Science in Biotechnology in the Jomo Kenyatta University of Agriculture and Technology.

2016

DECLARATION

This thesis is my original work and it has not been presented for a degree in any other university.

Signature..... Date.....

Catherine Medza Tsuma

This thesis has been submitted for examination with our approval as the University Supervisors.

Signature..... Date.....

Prof. Rebecca Waihenya
JKUAT Kenya

Signature..... Date.....

Prof. Matilu Mwau
Consortium for National Health Research, Kenya

DEDICATION

I give thanks to GOD almighty, for giving me this opportunity to have reached this far and to my family members for their constant prayers and encouragement.

ACKNOWLEDGEMENT

I would like to acknowledge my supervisors Prof Rebecca Waihenya and Prof Matilu Mwau for their wise counsel, sincere and genuine guidance, criticism and assistance at every step of this project and during the writing of this dissertation.

My gratitude goes to all staff and students of HIV laboratory (CVR), Hematology laboratory (CCR) and immunology laboratory (CBRD) KEMRI for their support and being there for me during this project. To all the staff under the Early Infant Diagnosis Program (E.I.D program); it would not have been any easy without your support.

My sincere gratitude to all the staff of Institute of Biotechnology Research (IBR) through its director Prof Aggrey Nyende for his encouragement and advice which gave moral support through the difficult period of achievement. My most gratitude also to Dr Remmy Kasili for his effort in my success.

To all the friends at heart the words of wisdom were received in good faith.

To all my family members the love shared paved way to this success.

TABLE OF CONTENT

DECLARATION.....	II
DEDICATION.....	III
ACKNOWLEDGEMENT	IV
TABLE OF CONTENT	V
LIST OF FIGURES	XIV
LIST OF TABLES	XVII
APPENDICES	XVIII
ABBREVIATIONS AND ACRONYMS.....	XIX
ABSTRACT.....	XXIII
CHAPTER ONE	1
INTRODUCTION.....	1
1.1 Background information.....	1
1.1.1 Human Immunodeficiency Virus.....	2
1.1.2 Hepatitis Virus.....	4
1.1.2.2 Hepatitis C virus.....	6

1.2 Statement of Problem	9
1.3 Justification.....	10
1.4 Research Gap	10
1.5 Research Hypothesis	11
1.6.1 General objective.....	11
1.6.2 Specific objectives	11
CHAPTER TWO	12
LITERATURE REVIEW.....	12
2.1 Entry of HIV into immune cells	12
2.1.1 Effect of HIV infection in immunity	12
2.2 Mechanisms of HIV-1-HCV interaction.....	13
2.3 Mechanisms of HIV-HBV interaction.....	16
2.4 Immunity to HIV/HCV/HBV infections.....	16
2.4.1 Immunity to acute HIV infection.....	16
2.4.2 Immunity to chronic HIV infection.....	17
2.4.3 Immunity to HCV infection.....	18
2.4.4 Immunity to HBV infection.....	18

2.5 Chemokines and their role during infection.....	19
2.5.1 Types of chemokines.....	20
2.5.2 Chemokine receptors.....	20
2.5.3 Role played by chemokines in infection.....	21
2.6 The role RANTES in HIV infection.....	22
CHAPTER THREE	25
MATERIALS AND METHODS	25
3.1 Study site.....	25
3.2 Study design.....	25
3.3 Sampling plan	25
3.3.1 Inclusion criteria.....	25
3.4 Sample size determination	26
3.5 Sample collection.....	26
3.6 Analysis of CD3, CD4 cell counts.....	26
3.7 Determination of differential count	26
3.8 Processing of dried blood spot (DBS) for HIV-1 diagnosis and DNA extraction	27

3.9 Separation of whole blood.....	27
3.10 HCV diagnosis	28
3.11 HBV diagnosis.....	28
3.12 HIV confirmation	29
3.13 DNA extraction from dried blood spots (DBS).....	30
3.14 Polymerase chain reaction of the RANTES G 28 polymorphism.....	31
3.15 Data analysis	32
3.16 Ethical consideration	32
CHAPTER FOUR.....	33
RESULTS	33
4.1 Seroprevalance of HIV-1/ HIV-1/HBV ,HIV-1/HCV and HIV-1/HBV/HCV co infections	33
4.2 The Mean levels of CD3, CD4, Absolute lymphocytes, Neutrophils, Monocytes, Eosinophils, Basophils and Platelets in presence of HIV-1, HIV-1/HBV, HIV- 1/HCV and HIV-1/HBV/HCV co infections.....	34
4.3 Correlation between HIV-1/HBV,HIV-1/HCV and HIV-1/HBV/HCV co infections on CD3, CD4 ⁺ T cells, absolute lymphocytes, neutrophils, monocytes ,eosinophils, basophils and platelets	34

4.3.1 Correlation between HIV-1/HBV co infection and CD3, CD4, absolute lymphocytes, neutrophils, monocytes, Eosinophils, basophils and platelets	35
4.3.2 Correlation between HIV-1/HCV co infection and CD3, CD4, absolute lymphocytes, neutrophils, monocytes, eosinophils, basophils and platelets	37
4.3.3 Correlation between HIV-1/HBV/HCV co infection and CD3, CD4, absolute lymphocytes, neutrophils, monocytes, eosinophils, basophils and platelets	38
4.4 RANTES G 28 activation during HIV-1 ,HIV-1/HBV,HIV-1/HCV co infection	39
4.4.1 Confirmation of expression of RANTES G 28 through Gel-electrophoresis39 for amplified RANTES G 28.....	39
4.4.2 Frequency of RANTES G 28 genotypes among HIV-1-infected, HIV-/HCV, HIV-1/HBV and HIV-1/HBV/HCV co infection.....	40
4.4.3 Effect of RANTES G 28 on HIV-1, HIV-1/HBV, HIV-1/HCV and	41
HIV-1/HBV/HCV co infections	41
4.4.4 Effect of RANTES G 28 on Leukocytes (CD3, CD4, absolute lymphocytes, neutrophils, monocytes, eosinophils, basophils and platelets)	42
4.5 Expression of RANTES G 28 in the presence of leukocytes (CD3, CD4, absolute lymphocytes, neutrophils, monocytes, eosinophils, basophils and platelets)	44

4.5.1 RANTES G 28 expression in presence of platelets infected with HIV-1 infection.....	44
4.5.2 RANTES G 28 expression in the presence of basophils infected with HIV-1 infection.....	45
4.5.3 RANTES G 28 expression on eosinophils infected with HIV-1 infection....	46
4.5.4 RANTES G 28 expression in presence of monocytes infected with HIV-1 infection.....	47
4.5.5 RANTES G 28 expressions in presence neutrophils infected with HIV-1 infection.....	48
4.5.6 RANTES G 28 expression on absolute lymphocytes infected with HIV-1 infection.....	49
4.5.7 RANTES G 28 expressions in presence of CD4 infected with HIV-1 infection.....	49
4.5.8 RANTES G 28 expressions in presence of CD3 infected with HIV-1 infection.....	50
4.6 Expression of RANTES G 28 in presence of HIV-1/HBVco infection.....	51
4.6.1 RANTES G 28 expression in presence of platelets infected with HIV-1/HBV co infection:	51
4.6.2 RANTES G 28 expression in presence of basophils infected with HIV-1/HBV co infection	52

4.6.3 RANTES G 28 expression in presence of monocytes infected with HIV-1/	
HBV co infection.	53
4.6.4 RANTES G 28 expression in presence of absolute lymphocytes infected	
with HIV-1/HBV co infection.....	54
4.6.5 RANTES G 28 expression in presence of eosinophils infected with HIV-	
1/HBV co infection.	55
4.6.6 RANTES G 28 expression in presence of CD4 infected with HIV-1/HBV	
co infection.	56
4.6.7 RANTES G 28 expressions in presence of CD3 infected with HIV-1/HBV	
co infection.	57
4.6.8 RANTES G 28 expression in presence of neutrophils infected with HIV-	
1/HBV co infection.	58
4.7 Expression of RANTES G 28 on leukocytes in presence of HIV-1/HCV	
co infection.....	59
4.7.1 RANTES G 28 expression in presence of CD4 infected with HIV-1/HCV	
co infection.	59
4.7.2 RANTES G 28 expression in presence of absolute lymphocytes infected	
with HIV-1/HCV co infection.....	60
4.7.3 RANTES G 28 expression in presence of neutrophils infected with HIV	
1/HCV co infection.	61

4.7.4 RANTES G 28 expression in presence of monocytes infected with HIV-1/HCV co infection.	62
4.7.5 RANTES G 28 expression in presence of eosinophils infected with HIV-1/HCV co infection	63
4.7.6 RANTES G 28 expression in presence of basophils infected with HIV-1/HCV co infection.	64
4.7.7 RANTES G 28 expression in presence of platelets infected with HIV-1/HCV co infection.	65
4.7.8 RANTES G 28 expression in presence of CD3 infected with HIV-1/HCV co infection.	66
4.8 Expression of RANTES G 28 in presence of HIV-1/HBV/HCV co infection ...	67
CHAPTER FIVE.....	69
DISCUSSION	69
5.1 Seroprevalance of HIV-1/ HIV-1/HBV, HIV-1/HCV and HIV-1/HBV/HCV co infection.....	69
5.2 Effects of HIV-1 Infection on leukocytes (CD4, CD3, absolute lymphocytes, neutrophils, monocytes, eosinophils, Basophils and platelets).....	70
5.3 Association between HIV-1 ,HBV and HCV infection.....	71
5.4 Effect of HIV-1/HBV co infection on CD4, CD3, absolute lymphocytes, Neutrophils, Monocytes, Eosinophils, Basophils and platelets.	72

5.5 Effects of HIV-1/HCV co infection on leukocytes (CD4, CD3, absolute lymphocytes, neutrophils, monocytes, eosinophils, basophils and platelets)	72
5.6 Effect of HIV-1/HCV/HBV co infection on CD4, CD3, absolute lymphocytes, Neutrophils, Monocytes, Eosinophils, Basophils and platelets.	74
5.7 Expression of RANTES G 28 in presence of HIV-1, HIV-1/HBV, HIV-1/HCV and HIV-1/HBV/HCV co infection	75
5.8 Effect of RANTES G 28 during HIV-1, HIV/HBV, HIV/HCV co infection on CD4, CD3, absolute lymphocytes, neutrophils, monocytes, eosinophils, basophils and platelets.	77
CHAPTER SIX	77
CONCLUSION, LIMITATIONS AND RECOMMENDATION.....	78
6.1 Conclusion	78
6.2 Limitation.....	79
6.3 Recommendation	79
REFERENCES.....	80
APPENDICES	98

LIST OF FIGURES

Figure 1.0: Schematic structure of HIV-1 envelope glycoprotein gp120 and gp41	3
Figure 1.1: Map of the hepatitis B virus (HBV).	5
Figure 1.2: The genomic structure of hepatitis C virus (HCV).	7
Figure 2.0: Mechanism of HCV-HIV interaction.	14
Figure 2.1: Schematic diagram of RANTES gene	23
Figure 4.0: Seroprevalance of HIV-1 infection, HIV-1/HBV, HIV-1/HCV and HIV1/HBV/HCV co infections	33
Figure 4.1: Gel-electrophoresis for amplified RANTES G 28	40
Figure 4.2: RANTES G 28 expression on the distribution of platelets in presence of HIV-1 infection showed expression of RANTES G 28.	44
Figure 4.3: The expression of RANTES G 28 in presence basophils distribution (cell/mm ³) infected with HIV-1.....	45
Figure 4.4: The expression of RANTES G 28 on eosinophils distribution (cell/mm ³) infected with HIV-1 infection.	46
Figure 4.5: The expression of RANTES G 28 in presence monocytes distribution (cell/mm ³) infected with HIV-1 infection.....	47
Figure 4.6: Expression of RANTES G 28 on neutrophils distribution (cell/mm ³) infected with HIV-1 infection	48

Figure 4.7: Expression of RANTES G 28 on absolute lymphocytes infected with HIV-1 infection.	49
Figure 4.8: Expression of RANTES G 28 on CD4 distribution (cell/mm ³) infected with HIV-1 infection.	50
Figure 4.9: Expression of RANTES G 28 on CD3 distribution (cell/mm ³) infected with HIV-1 infection.	51
Figure 4.10: Expression of RANTES G 28 on platelets distributions (cells/mm ³) infected with HIV-1/HBV co infection.	52
Figure 4.11: Expression of RANTES G 28 in presence of basophils infected with HIV-1/HBV co infection.....	53
Figure 4.12: The expression of RANTES G 28 at various cells distribution of monocytes (cells/mm ³) infected with HIV-1/HBV co infection.	54
Figure 4.13: Expression of RANTES G 28 at various cell distributions (cells/mm ³) of absolute lymphocytes infected with HIV-1/HBV co infection.	55
Figure 4.14: The RANTES G 28 is expressed at various cell distributions (cells/mm ³) of eosinophils infected with HIV-1/HBV co infection.....	56
Figure 4.15: Expression of RANTES G 28 at various cell distributions (cells/mm ³) of CD4 infected with HIV-1/HBV co infection.....	57
Figure 4.16: The expression of RANTES G 28 at various CD3 distributions (cells/mm ³) infected with HIV-1/HBV co infection.....	58

Figure 4.17: The expression of RANTES G 28 at various cell distributions (cells/mm ³) of neutrophils infected with HIV-1/HBV co infection.....	59
Figure 4.18: The expression of RANTES G 28 at various cell distributions (cells/mm ³) of CD4 infected with HIV-1/HCV co infection.	60
Figure 4.19: Expression of RANTES G 28 at various cell distributions (cells/mm ³) of absolute lymphocytes infected with HIV-1/HCV co infection.	61
Figure 4.20: Expression of RANTES G 28 at various cell distributions (cells/mm ³) of neutrophils infected with HIV-1/HCV co infection.	62
Figure 4.21: Expression of RANTES G 28 at various cell distributions (cells/mm ³) of monocytes infected with HIV-1/HCV co infection.....	63
Figure 4.22: Expression of RANTES G 28 at various cell distributions (cells/mm ³) of eosinophils infected with HIV-1/HCV co infection.....	64
Figure 4.23: Expression of RANTES G 28 at various basophils distribution (cells/mm ³) infected with HIV-1/HCV co infection.....	65
Figure 4.24: Expression of RANTES G 28 at various cell distributions (cells/ μ L) of platelets infected with HIV-1/HCV co infection.....	66
Figure 4.25: Expression of RANTES G 28 at various cell distributions of CD3 (cells/mm ³) infected with HIV-1/HCV co infection.....	67
Figure 4.26: Expression of RANTES G 28 at various stated cell distributions infected with HIV-1/HBV/HCV co infection.	68

LIST OF TABLES

Table 4.0: The mean distribution of CD3, CD4, absolute lymphocytes, neutrophils, monocytes, eosinophils, basophils and platelets in HIV-1 infection, HIV-1/HBV, HIV-1/HCV and HIV-1/HBV/HCV co infections	34
Table 4.1: Correlation between HIV-1/HBV co infection and CD3, CD4+ T cells, absolute lymphocytes, neutrophils, monocytes, eosinophils, basophils and platelets.....	36
Table 4.2: Correlation between HIV-1/HCV co infection and CD3, CD4+ T cells, absolute lymphocytes, neutrophils, monocytes, Eosinophils, basophils and platelets.....	37
Table 4.3: Correlation between HIV-1/HBV/HCV co infection and CD3, CD4, absolute lymphocytes, neutrophils, monocytes, eosinophils, basophils and platelets	38
Table 4.4: Frequency distribution of RANTES G 28 among HIV-1-infected, HIV-1/HCV and HIV-1/HBV co infection.....	41
Table 4.5: Effect of RANTES G 28 on HIV-1 infection, HIV-1/HBV, HIV-1/HCV and HIV-1/HBV/HCV co infections.....	42
Table 4.6: Expression of RANTES G 28 on CD3, CD4, absolute lymphocytes, neutrophils, monocytes, eosinophils, basophils and platelets	43

APPENDICES

Appendix 1 :	EtBr (ethidium bromide 5 mg / ml).....	98
Appendix 2:	Distribution of leukocytes	99
Appendix 3:	Comparison of CD4 Ranges in HIV Negative Individuals	100
	Comparison of CD4 Ranges in HIV Negative Individuals Ordered by Mean CD4 Count, CD4 Count for the different geographical regions in Kenya.....	100
Appendices 4:	A memorandum for understanding between The Clinton foundation HIV-1/AIDS Initiative and Kenya Medical Research Institute (KEMRI), NAIROBI for HIV testing and monitoring CD4 in HIV infected persons	101

ABBREVIATIONS AND ACRONYMS

AIDS	Acquired immune Deficiency
ALT	Alanine aminotransferase
Bp	Base pairs
CBRD	Centre Biotechnology Research Development
CCR1	CC receptor 1
CCR5	CC receptor 5
CD3	Cluster of differentiation 3
CD38	Cluster of Differentiation type 38
CD4	Cluster of differentiation type 4
CD8	Cluster of Differentiation 8
CPE	Cytopathic effect
CTL	cytotoxic T lymphocyte
CTL	Cytotoxic T Lymphocytes
CTL	cytotoxic T-lymphocyte
CXCR3	Chemokine Receptor type 3
CXCR4	Chemokine Receptor type 4

CXCR6	Chemokine Receptor type 6
DARC	Duffy antigen of erythrocytes
DBS	Dried blood spot
DD	Double distilled
dntp	deoxynucleotide triphosphate
dsDNA	double-stranded DNA
EDTA	Ethylene diamine tetra acetic Acid
ERC	Ethical Research Committee
EtBr	Ethidium bromide
gp	glycoprotein
HBcAg	Hepatitis B c Antigen
HBeAg	Hepatitis B e antigen
HBsAg	Hepatitis B surface Antigen
HBV	Hepatitis B virus
HCV	Hepatitis C virus
HIV	Human immunodeficiency virus
HLA-B27	Human leukocyte antigen B27

HLA-DR	Human leukocytes Antigens-DR
HSCs	Hepatic stellate cells
IFN	Interferon
JKUAT	Jomo Kenyatta University of Agriculture and Technology
KEMRI	Kenya Medical Research Institute
LPS	Lipopolysaccharide
MCP-1	Monocyte chemoattractant protein-1
MHC-I	Major histocompatibility complex class-1
MIP	Macrophage inflammatory protein
NK	Natural killer
PCR	Polymerase chain reaction
PTK	Protein tyrosine kinase
RANTES	Regulated upon Activation Normal T cell Expressed and Secreted
RIG-I	Retinoic-acid-inducible gene I
RNA	Ribonucleic acid
SRC	Scientific research committee
SNP	Single nucleotide polymorphisms

TGF-β	Transforming growth factor beta
Th	T helper
TLR3	Toll like receptor 3
TMB	Tetramethylbenzidine
TNF-α	Tumor necrosis factor alpha
UN	United Nations
WHO	World Health Organization
WBC	White blood cell

ABSTRACT

Human immunodeficiency virus (HIV)-1, co infection with hepatitis B virus (HBV) and hepatitis C virus (HCV) challenges the immune system. Regulated on activation normal T cell expressed and secreted (RANTES) is one of the natural ligands for the chemokine during infections such as HIV and by use of receptors ligand processes potently suppresses viral infection. The purpose of the study was to determine the effects of HIV-1 on leukocytes while in association with HBV and HCV co infection, with possible of activation of RANTES G 28. Absolute CD4+, CD3+ count was determined by FACS caliber machine of Becton Dickinson while differential counts were analyzed by Abacus 5 automated Blood Analyzer. HCV was serotyped using HCV ELISA–MUREX anti-HCV while HBV using HBV Elisa-Hepanostika HBsAg Ultra. HIV-1 was determined by COBAS[®] AmpliPrep/COBAS[®] TaqMan. DNA was extracted using Qiagen reagents and Polymerase Chain reaction (PCR) was carried out using conventional PCR. The mean \pm SD level of CD4 and neutrophils was lower than normal range but high with absolute lymphocytes. The effect of HIV-1/HBV reduced with an additional effect of CD3, CD4, absolute lymphocyte, basophils and platelets. The effect of HIV-1/HCV co infection reduced with an additional effect of CD4, absolute lymphocytes, neutrophils, eosinophils and basophils and the effect of HIV-1/HBV/HCV coinfection reduced with additional effect of CD4, absolute lymphocytes, eosinophils and basophils. Out of the total blood samples, 76.9% HIV-1 expressed RANTES G 28, HIV-1/HBV (86%), HIV-1/HBV (83%) and HIV-1/HBV/HCV co infection (100%). RANTES G 28 positively correlated with HIV-1, HIV-1/HBV, HIV-1/HCV and HIV-1/HBV/HCV co infections, and also with all the leukocytes. The effect of RANTES G 28 effect was to increase in presence of HIV-1 infection, HIV/HBV and HIV-1/HBV/HCV co infection. RANTES G 28 effect also increased with additional effect of CD3, CD4, absolute lymphocytes, monocytes and platelets. A positive correlation was between RANTES G 28 and all the leukocytes. RANTES G 28 expression presented a

mean \pm SD levels of the maximum response of leukocytes to RANTES G 28 during the infections. Study generated baseline data conceived to be useful in monitoring the effect of HIV-1 infection, HIV-1/HBV, HIV-1/HCV infection on leukocytes also in presence of RANTES G 28. More research is required on HIV-1 and in presence of co infection and RANTES G 28.

CHAPTER ONE

INTRODUCTION

1.1 Background information

Immune activation is a hallmark of infection and with the impacts on innate and adaptive immunity (Champagne *et al.*, 2001). Most viral infections induce cellular and humoral immune responses that act to limit viral spread, clear infection and provide protective immunity against reinfection with the same virus (Champagne *et al.*, 2001), however, a number of viruses have evolved varied and sophisticated mechanisms to establish persistent infection, even in immunocompetent hosts (Champagne *et al.*, 2001). Chronic immune activation is a characteristic feature of Human immunodeficiency virus (HIV-1) infection contributing to Cluster of differentiation type 4 cells (CD4⁺) T cell loss and progression to Acquired immune Deficiency (AIDS) and death (Brenchley *et al.*, 2004). Persistent immune activation is characterized by elevated levels of serum cytokines and chemokines (Valdez & Lederman 1998). HIV-infected or HIV-specific T cells exhibit increased levels of activation and turn-over (Valdez & Lederman 1998).

Also directly or indirectly affected by the virus, including Cluster of Differentiation 8 (CD8) T cells, monocytes, macrophages, B lymphocytes, neutrophils and dendritic cells (Zhang *et al.*, 2003; Zhu *et al.*, 2002; Meltzer *et al.*, 1990; Moir *et al.*, 2001; Macatonia *et al.*, 1990). Dysfunction of these cells plays a major role in particular aspects of HIV pathogenesis (Foley *et al.*, 1992). As a consequence HIV-infected individuals have various perturbations of their immunological status, such as an inability to respond to recall antigens (Foley *et al.*, 1992), inappropriate responses to vaccinations (Veiga *et al.*, 2006), permanent hyperactivation states (Sousa *et al.*, 2002) with paradoxical hyporesponsiveness to stimuli (Gruters *et al.*, 1990), cell cycle deregulation (Galati and Bocchino, 2007) and imbalances in the production of cytokines (Barcellini *et al.*, 1994).

1.1.1 Human Immunodeficiency Virus

The Human Immunodeficiency Viruses (HIV) (Figure 1.0) is a member of the family of Retroviruses, in the genus of Lentiviruses (Weiss *et al.*, 2004). Retroviruses have been found in various vertebrate species, associated with a wide variety of diseases, in both animals and humans (Weiss *et al.*, 2004). In particular, retroviruses have been found to be associated with malignancies, autoimmune diseases, immunodeficiency syndromes, aplastic and haemolytic anaemias, bone and joint disease and diseases of the nervous system (Weiss *et al.*, 2004). The human immunodeficiency viruses (HIV) are approximately 100 nm in diameter and has a lipid envelope, in which are embedded the trimeric transmembrane glycoprotein gp41 to which the surface glycoprotein gp120 is attached. These two viral proteins are responsible for attachment to the host cell and are encoded by the *env* gene of the viral RNA genome (Cleghorn *et al.*, 2005).

The main attachment receptor for HIV is the CD4 molecule that is present on the CD4 positive T (helper) lymphocyte, macrophages, and microglial cells (Cleghorn *et al.*, 2005). The viral gp120 binds initially to this CD4 molecule, which then triggers a conformational change in the host-cell envelope that allows binding of the co-receptor (either CCR5 or CXCR4) which is required for fusion between virus envelope and cell membrane (Weiss *et al.*, 2004). Macrophages carry the CCR5 co-receptor; hence HIV strains requiring the CCR5 co-receptor for entry are also referred to as 'macrophage-tropic' although they also infect lymphocytes (Cleghorn *et al.*, 2005).

All retroviruses encode a reverse transcriptase enzyme that transcribes its viral RNA into double-stranded DNA (dsDNA), which is then integrated, via the action of the integrase enzyme into the host-cell genome (Damond *et al.*, 2004). The viral integrated dsDNA or 'provirus' then acts as a template for viral genomic and messenger RNA transcription by the host cell's nucleic acid replicating machinery (Damond *et al.*, 2004).

The HIV infection induces a state of immune activation, which is responsible in part for the immune pathogenesis of the disease (Champagne *et al.*, 2001). The virus escapes from the immune surveillance by mechanisms such as mutations of immunodominant Cytotoxic T Lymphocytes (CTL) epitopes and down regulation of major histocompatibility complex class-1 (MHC-I) molecules on the infected cells (Champagne *et al.*, 2001).

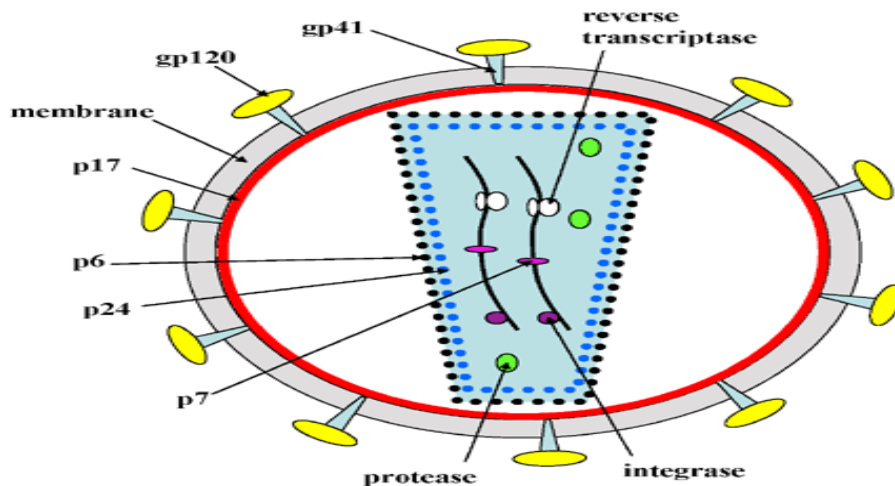

Figure 1.0: Schematic structure of HIV-1 envelope glycoprotein gp120 and gp41

Source: Principles and Practice of Infectious Diseases, 6th ed. pp2119-2133. (Cleghorn *et al.*, 2005)

Acquired Immunodeficiency Syndrome (AIDS) is caused by a HIV. The virus infects certain types of white blood cells, principally CD4 cells (also called helper cells or T4-cells) and monocytes/macrophages (Nelson *et al.*, 1988). The CD4 cells and macrophages both have important functions in the immune system (Nelson *et al.*, 1988). The disruption of the function of these cells lies at the heart of the immunodeficiency that characterizes AIDS (Nelson *et al.*, 1988). This syndrome represents the late clinical stage of HIV infection resulting from progressive damage to the immune system, leading

to one or more of the many opportunistic infections and cancers listed in the case definition (American Public Health Association. Heymann DL, 2008). AIDS is a syndrome, and is not transferable, but the HIV virus, which leads to AIDS, is transmitted from person to person (Nelson, J. *et al.*, 1988).

The HIV infection disrupts the functioning of the immune system and a weakened immune system allows the development of a number of different infections and cancers, and these diseases which causes illness and death in people with AIDS (Pomerantz *et al.*, 1987). HIV also infects and causes direct damage to other types of cells: for example, damage to the lining of the intestine can contribute to wasting (severe weight loss); damage to nerve cells can cause neurological problems (Elder, G & Sever, J, 1988). The time from HIV infection to the diagnosis of AIDS has a range from less than one year to 18 years or longer (National Collaborating Centre for Infectious Diseases (NCCID), 2008).

Epidemiological evidence suggests that transmissibility begins early after the onset of HIV infection and extends throughout life (Pickering *et al.*, 2009). Infectiousness is highest during the initial infection, and rises with increasing immune deficiency. The presence of other STIs, especially ulcerative STIs, increases the likelihood of transmission (Pickering *et al.*, 2009).

1.1.2 Hepatitis Virus

1.1.2.1 Hepatitis B virus

Worldwide, about 90% of HIV-positive patients have evidence of previous Hepatitis B virus (HBV) infection, whereas 10% of the HIV-positive population has evidence of chronic HBV infection (Kellerman *et al.*, 2003). Hepatitis B virus (HBV) (figure 1.2) is more common in human immunodeficiency virus (HIV)–infected individuals than in the general population owing to shared risk factors for viral acquisition (Kellerman *et al.*,

2003). The HIV infection has an adverse impact on HBV-related liver disease progression with higher serum HBV DNA polymerase activity, lower rates of loss of serum hepatitis B e antigen (HBeAg), increased risk of cirrhosis, liver-related mortality, and hepatocellular carcinoma at lower CD4 T-cell counts (Mathews *et al.*, 2003).

Liver-related mortality is higher in chronic HIV and HBV co-infection than in HIV or HBV infection alone because of an accelerated fibrosis progression rate (Thio *et al.*, 2002).

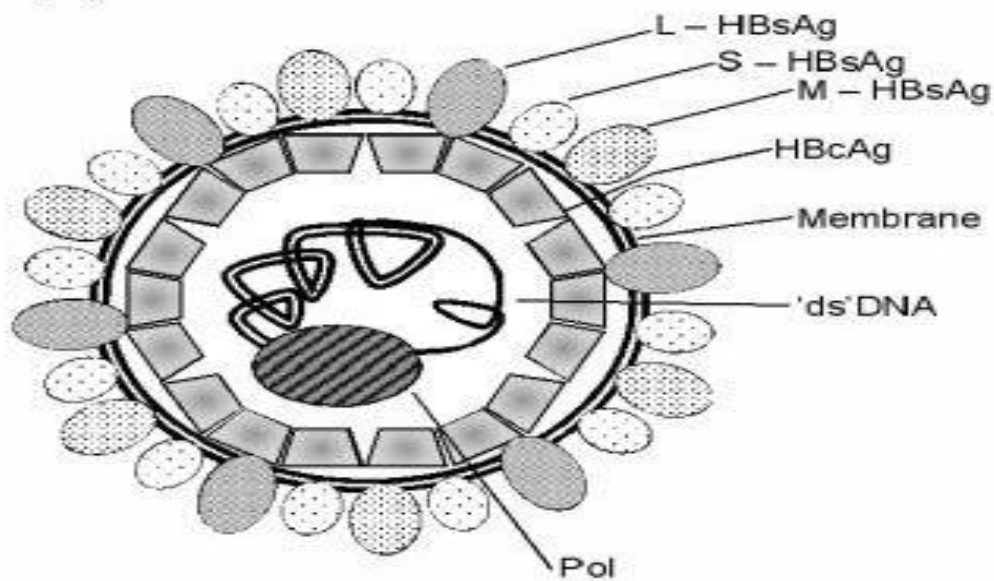

Figure 1.1: Map of the hepatitis B virus (HBV).

Source: *J Infect Dis.* 188: 571–77- (Kellerman *et al.*, 2003)

1.1.2.2 Hepatitis C virus

Hepatitis C virus (HCV) (Figure 1.3) is a positive-stranded ribonucleic acid (RNA) virus belonging to the Flavi viridae family (Rehermann *et al.*, 2009). Six major HCV genotypes have been identified and more than 100 subtypes have been identified throughout the world on the basis of molecular relatedness of conserved and non-conserved regions (Rehermann *et al.*, 2009). Several distinct but closely related HCV sequences coexist within each infected individual referred to as quasi-species (Rehermann *et al.*, 2009). They reflect a high replication rate of the virus and the lack of a proofreading capacity of the RNA-dependent RNA polymerase (Rehermann *et al.*, 2009). More than 170 million people worldwide are chronically infected with HCV, which is a major cause of chronic hepatitis, cirrhosis, and hepatocellular carcinoma (Rehermann *et al.*, 2009).

A correlation between symptomatic disease and viral clearance has been reported, possibly due to a more vigorous immune response, which also results in greater liver injury (Gerlach *et al.*, 2003). In chronic HCV infection, the liver is typically infiltrated by mononuclear cells including CD4⁺ and CD8⁺ T lymphocytes, B lymphocytes, as well as natural killer (NK) cells (CD56⁺CD3⁻) and NK T cells (CD56⁺CD3⁺) (Maria Giovanna *et al.*, 2012).

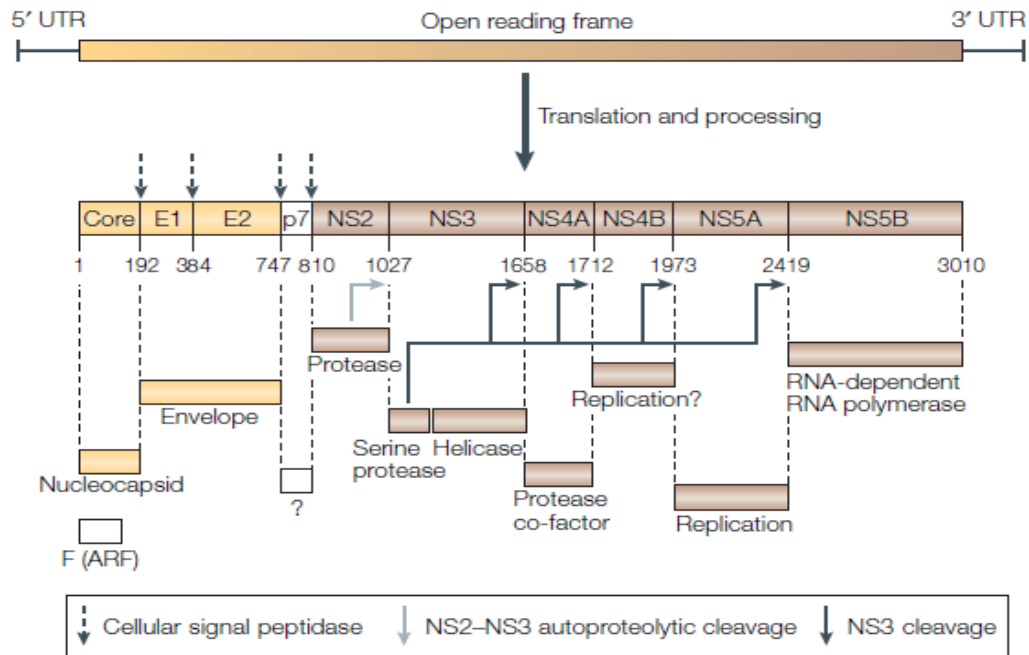

Figure 1.2: The genomic structure of hepatitis C virus (HCV).

Source: Immunology of Hepatitis B Virus and Hepatitis C Virus infection vol 5. Pg 219
(Barbara & Michelina, 2005)

1.1.2.3 HIV/Hepatitis co infection

Due to shared modes of transmission, as many as 30 to 40% of people infected with HIV may also be coinfecting with HCV or HBV (Vlahakis *et al.*, 2003). Moreover, HIV-1, Hepatitis co infection is a significant problem among injection drug users (IDUs) as well as men who have sex with men (MSMs) and HIV can worsen hepatitis C infection (Vlahakis *et al.*, 2003). HIV/HCV co-infection has been associated with a faster rate of hepatitis C disease progression, higher HCV viral loads, and a greater risk of developing severe liver damage (Vlahakis *et al.*, 2003).

HIV-1 and HCV infections are both major global health problems. The HIV-1 pandemic has claimed over 20 million lives and more than 33 million people are estimated to be living with HIV-1/AIDS worldwide (UN AIDS, (2010). The HCV infects 170 million people globally (World Health Organization, 2011) and the majority of these infected individuals develop chronic hepatitis thereby becoming a potential source of HCV transmission (Backmund *et al.*, 2001). Due to their shared routes of transmission, HIV-1 and HCV co infection affects approximately 25–33% of HIV-1-infected persons (Backmund *et al.*, 2001). HIV-1 co infection accelerates HCV-related liver injury, resulting in faster development of cirrhosis and end-stage liver disease (Benhamou *et al.*, 1999).

The accelerated progression of liver disease due to HIV-1 and HCV co infection has emerged as a leading cause of death in HIV-1-infected persons (Koziel *et al.*, 1999). The liver injury in HCV infection is thought to be mainly due to attacks of immune responses and of inflammatory factors rather than a direct cytopathic effect (CPE) of the virus itself (Koziel *et al.*, 1999). Acute HCV infection in humans or chimpanzees shows that high levels of viremia are detectable for several weeks before the onset of hepatitis, suggesting that HCV is not directly cytopathic (Koziel *et al.*, 1999). Following HCV infection, the immune system responds to viral components by activating immune cells to specifically combat the viral infection. However, when this vigorous immune response fails to eliminate the virus, chronic infection is established (Koziel *et al.*, 1999). This results in an ongoing process of hepatic apoptosis, inflammation, regeneration and fibrosis that in many cases leads to the development of cirrhosis and of hepatocellular carcinoma (HCC) (Koziel *et al.*, 1999).

Among the cytokines, increased intrahepatic expressions of tumor necrosis factor alpha (TNF- α), transforming growth factor beta (TGF- β) have been observed in persons with chronic HCV infection (Blackard *et al.*, 2006). These cytokines have been recognized as key regulators in liver damage (Blackard *et al.*, 2006). The suppression of intrahepatic

cytokines during HIV-1, HCV co infection lead to an imbalance between pro-fibrogenic and anti-fibrogenic cytokines (Blackard *et al.*, 2006), thus favoring liver fibrosis and HCV replication in the liver, increases the risk of cirrhosis and end-stage liver disease in HCV co infection (Blackard *et al.*, 2006).

Hepatic damage in chronic HBV infection is predominantly immune mediated, with CD8 cytotoxic T lymphocytes targeting HBV antigens on infected hepatocytes, resulting in hepatocellular inflammation and necrosis (Perrillo, 2001). Co infection with HIV alters the natural history of HBV disease resulting in higher rates of hepatitis B e antigen (HBeAg), and higher levels of HBV DNA but lower alanine aminotransferase (ALT) levels (Harcourt *et al.*, 2006). This cause's similar or reduced necroinflammatory activity noted upon histological examination and liver disease progresses (Harcourt *et al.*, 2006). HIV-infected Kupffer cells shift to a T helper (Th) 2 cytokine response, in turn influencing the hepatic stellate cells (HSCs), the major mediators of collagen deposition and fibrogenesis in the liver (Harcourt *et al.*, 2006).

1.2 Statement of Problem

Upon viral infections, the cells of immunity are recruited and activated at the site of infection but the rate of viral load and spread of the infection increases with time in the host. The HIV-1/HBV/HCV co infections affect cells of immune system and cause immune dysfunction. Due to infections, the body system elicits different types of molecules unknown to many people, said to have immune characteristics but needed to be studied and understood. RANTES G 28 is a chemokine that regulate protective immunity to viral infection and has complex effect on the variety of cell. The chemokine bind to receptors and may play an important part in controlling the extent of the infection in the early pathogenesis of the disease. During the HIV-1/HBV/HCV co infection, RANTES G 28 is said to be expressed by the leukocytes; it has effects on the recruitment and attraction of leukocytes to the sites of infection and the association of

RANTES G 28 on leukocytes in presence of HIV-1/HBV/HCV co infection. However there is a need to establish the expression of RANTES G 28 in the presence of HIV-1 infection, HIV-1/HBV and HIV-1/HCV co infections and the leukocytes.

1.3 Justification

Due to increased cases of symptomatic and asymptomatic HIV-1 infection, HIV-1/HBV, HIV-1/HCV co infections, there is a need to understand the interaction of cells of immune system. The chemokine system is critically involved in the control of viral replication by virtue of the role played by specific chemokine receptors such as RANTES receptor on leukocytes. This plays a critical role in pathogenesis of the viral infection disorders. RANTES being a protective chemokine could play an important role during HIV-1 infection, HIV-1/HBV and HIV-1/HCV co infections. However there is a need to establish the expression of RANTES G 28 in the presence of HIV-1 infection, HIV-1/HBV and HIV-1/HCV co infections and its effect on leukocytes. This will create an understanding of the regulatory and protective immunity expressed during the infections and the chemo potent attractant of immune cells to the site of infections. This study seeks to establish the expression and the effects of RANTES G 28 on the leukocytes in the presence HIV-1infection, HIV-1/HBV, and HIV-1/HCV co infections. This will generate baseline data that is usefully in the management of the co infections.

1.4 Research Gap

Some chemokines are expressed during HIV-1, HIV/HBV and HIV/HCV co infections. Activation of RANTES G 28 will be a useful tool in management and development of immunity; however the expression and the effects of RANTES G 28 in cells of immune system need to be investigated

1.5 Research Hypothesis

- i. HIV-1 infection, HIV/HCV, HIV/HBV co infection has no effects on the distribution of the leucocytes.
- ii. RANTES G 28 is not expressed during HIV-1 infection, HIV/HCV, HIV/HBV co infection
- iii. RANTES G 28 has no effect on the distribution of leucocytes

1.6 Research Objectives

1.6.1 General objective

To determine the effect of HIV-1 infection, HIV/HBV, HIV/HCV co infections on leukocytes in the presence of activated RANTES G 28.

1.6.2 Specific objectives

- 1) To determine the sero prevalence of HIV-1 infection, HIV-1/HBV and HIV-1/HCV co infections.
- 2) To evaluate the effects of HIV-1 infection on leukocytes.
- 3) To analyze the effects of HIV-1 infection on leukocytes in association with HBV and HCV co infection.
- 4) To determine the presence of activated SNP RANTES G 28 in HIV infection and in co infection with HBV and HCV and its effect on the leukocytes.

CHAPTER TWO

LITERATURE REVIEW

2.1 Entry of HIV into immune cells

During HIV infection, the perturbation of the adaptive and innate immune responses contributes to the progressive immune suppression leading to an increased susceptibility to opportunistic infections and neoplastic diseases (Peterlin & Trono, 2003). This causes gradual loss of CD4⁺ T cells, CD8⁺ T cell dysfunction, decreased number and function of natural killer(NK) cells which can be a consequence of the functional impairment and variation in the number of dendritic cells (DC) associated with HIV infection (Peterlin & Trono, 2003). Dendritic cells represent a viral reservoir acting as primary target and HIV carriers for infection of permissive CD4⁺ T cells, facilitating the onset of infection and its dissemination to surrounding permissive cells (Peterlin & Trono, 2003).

2.1.1 Effect of HIV infection in immunity

HIV-1 infection causes a slow but progressive impairment of the immune system, which is accompanied by a chronic hyperactivation of CD4⁺ and CD8⁺ T cells (Brenchley *et al.*, 2004). Infected patients display expression of various activation markers such as Human leukocytes Antigens-DR (HLA-DR) and Cluster of Differentiation type 38 (CD38) in both CD4 and CD8 T cells (Boasso & Shearer, 2008). Reduced CD4⁺ and CD8⁺ T-cell counts during HIV-1 infection affect the naive T-cell compartment, evidence indicates that both de novo production of new cells and peripheral homeostatic division of existing cells participate to naive T-cell renewal (Vrisekoop *et al.*, 2008).

An effective cytotoxic T lymphocyte (CTL) response is essential for the immune system to control HIV (Vrisekoop *et al.*, 2008). In HIV infection, circulating Lipopolysaccharide (LPS) is associated with increased secretion of proinflammatory cytokines and

decreased frequencies of CD4⁺ T cells as well as the selective loss of T helper 17 (Th17) T cells (Brenchley *et al.*, 2006).

The HIV infection leaves the host vulnerable to opportunistic infections, Other cells are also directly or indirectly affected by the virus, including CD8⁺ T cells (Zhang *et al.*, 2003), monocytes (Zhu *et al.*, 2002), macrophages (Meltzer *et al.*, 1990), B lymphocytes (Moir *et al.*, 2001), neutrophils (Gabrilovich *et al.*, 1993) and dendritic cells (Macatonia *et al.*, 1990). As a consequence, HIV-infected individuals have various perturbations of their immunological status, such as an inability to respond to recall antigens (Foley *et al.*, 1992), inappropriate responses to vaccinations (Veiga *et al.*, 2006), permanent hyperactivation states (Boasso & Shearer 2008) with paradoxical hyporesponsiveness to stimuli (Gruters *et al.*, 1990), cell cycle dysregulation (Galati *et al.*, 2007) and imbalances in the production of cytokines (Barcellini *et al.*, 1994).

2.2 Mechanisms of HIV-1-HCV interaction

Co infection of HIV-1/HCV has a significant impact on the life cycle of HCV and on the natural history of HCV infection (figure 2.0).

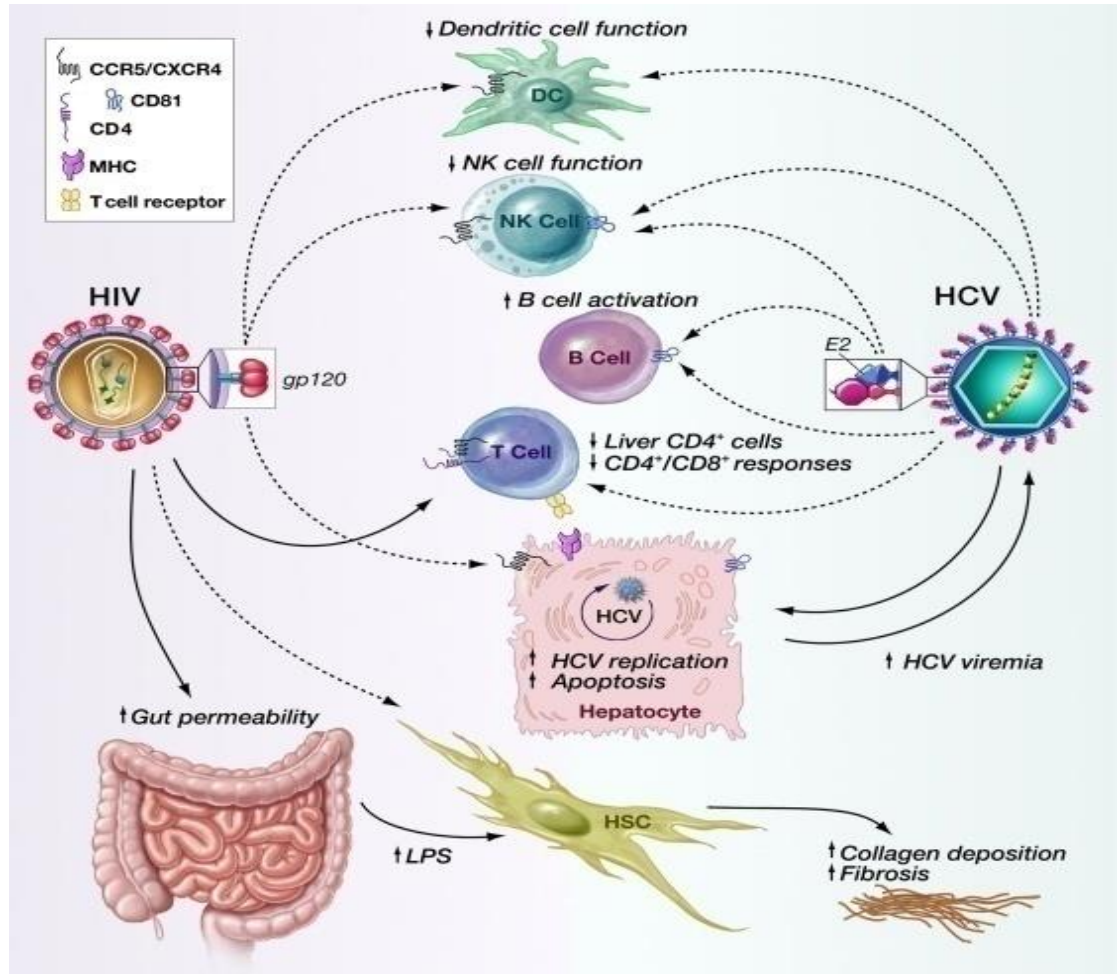

Figure 2.0: Mechanism of HCV-HIV interaction.

Source: Yaron and Liang, 2009.

The HIV/HCV co infection on the natural history of HCV is the acceleration of liver disease progression associated with a higher mortality than mono-infection with either virus alone (Bica *et al.*, 2001). Most liver-related deaths occur in HIV/HCV co-infected patients with low CD4⁺ counts (Bica *et al.*, 2001). The liver-associated mortality in co

infected patients is due to end-stage liver disease or hepatocellular carcinoma (Bica *et al.*, 2001). In HCV/HIV co infected patients, the degree of inflammation in the liver and the rate of fibrosis progression are higher than those in HCV-monoinfected patients (Vlahakis *et al.*, 2003). The HIV envelope protein gp120 induces apoptosis of hepatocytes through Chemokine Receptor type 4 (CXCR4) G-protein-mediated signaling (Vlahakis *et al.*, 2003). It also induces the expression of transforming growth factor β 1, which is known to be profibrotic with in vitro exposure of hepatocytes to HCV E2 protein (Vlahakis *et al.*, 2003).

Hepatic sinusoidal endothelial cells express CD4 and can be infected in vitro with HIV (Brenchley *et al.*, 2004). During primary HIV infection, is associated with increased gut permeability and microbial translocation reflected by increased lipopolysaccharide levels, causing a systemic immune act (Brenchley *et al.*, 2004). Gut permeability and lipopolysaccharide (LPS)-induced Kupffer cell activation are associated with liver injury in several conditions. Upon repeated exposure to LPS, monocytes and macrophages develop tolerance that limits their immune activation (Brenchley *et al.*, 2004). In chronic hepatitis C, this tolerance to LPS is lost in peripheral monocytes and possibly in Kupffer cells due to the combined effects of gamma interferon, endotoxin, and HCV core protein (Brenchley *et al.*, 2004).

The HCV-infected patients exhibit evidence of polyclonal proliferation of B cells with an autoantibody production, which can lead to the clinical syndromes of HCV-associated autoimmune disorders, example, mixed cryoglobulinemia, and non-Hodgkin's lymphoma (Ferri *et al.*, 2007). HCV has also been implicated in inhibiting NK cell function by an interaction of E2 and CD81 (Tseng *et al.*, 2002) and affecting the functions of T cells (Piguet *et al.*, 2007). HIV alters the functions and phenotypes of dendritic and natural killer (NK) cells (Piguet *et al.*, 2007); both of which play important roles in innate and adaptive immunity and likely contribute to the diminished HCV-specific immune response in coinfecting individuals (Piguet *et al.*, 2007).

2.3 Mechanisms of HIV-HBV interaction

Co infection of HIV-1 with HBV alters the natural history of HBV infection, and individuals with HIV-1/HBV co infection seroconvert from HBV e (precore) antigen (HBeAg) to HBV e antibody less frequently and have higher HBV DNA levels but lower levels of alanine aminotransferase (ALT) and milder necro inflammatory activity on histology than those infected with HBV alone (Piroth *et al.*, 2005). Progression to cirrhosis is rapid and liver related mortality is higher, in HIV-1/HBV co infection than with either infection alone (Piroth *et al.*, 2005).

2.4 Immunity to HIV/HCV/HBV infections

2.4.1 Immunity to acute HIV infection

Acute or primary HIV infection is the first period of infection for the detection of HIV RNA until the formation of HIV-specific antibodies 3-4 weeks after infection (McMichael *et al.*, 2010). The virus first replicates locally in the vaginal or rectal mucosa before detectable viral RNA in plasma (the eclipse phase) (McMichael *et al.*, 2010). Innate immune activation occurs due to recruiting granulocytes, macrophages, and lymphocytes, which are cellular targets of the virus (Moir *et al.*, 2000). The virus or virus-infected cells then reach the draining lymph nodes, where activated CD4⁺CCR5⁺ T cells are encountered and represent targets for further infection (Moir *et al.*, 2000).

The infection cause massive depletion of CD4⁺ memory T cells, primarily in mucosal tissue, with high expression of the viral co-receptor CCR5 (Guadalupe *et al.*, 2003). Dramatic depletion of CD4⁺CCR5 memory T cells predominantly from mucosal surfaces leads to failure of the host immune defenses and progression to AIDS (Kahn *et al.*, 1998). The viral load decreases over 12-20 weeks to reach a stable viral set point and this initiates a more chronic phase of the infection (Demarest *et al.*, 1994).

Following exposure at mucosal surfaces, HIV is transmitted with very low transmission efficiency, indicating that innate antiviral mechanisms are operative to prevent its establishment (Demarest *et al.*, 1994).

2.4.2 Immunity to chronic HIV infection

Massive immune activation and an accelerated cell turnover take place during chronic HIV infection (Ford *et al.*, 2009). This cause an increased expression of activation markers, such as CD38, HLA-DR , a surrogate marker for immune activation, disease progression to AIDS, and death (Ford *et al.*, 2009). Immunological damage to the gastrointestinal tract leads to breaks in the mucosal barrier allowing translocation of microbial products (Brenchley *et al.*, 2006), including bacterial lipopolysaccharide (LPS) into the circulation and bacterial translocation during HIV infection. Correlated plasma LPS levels leads to immune activation and only source of the microbial burden responsible for chronic immune activation (Brenchley *et al.*, 2006).

HIV viral constituents, such as glycoprotein (gp)120, nef, or viral nucleic acids produced during viral replication, subsequently results in activation of proinflammatory cytokines and type I interferon (IFN), including IFN- α and IFN- β (Boasso & shearer, 2008). Immune activation leads to depletion of CD4⁺ T cells by different mechanisms, including a decrease in CD4⁺ and CD8⁺ T cell half-life, abnormal T cell trafficking, clonal exhaustion of T cells, and drainage of memory T cell pools (Grossman *et al.*, 2006) causing minority of activated T cells, causing accelerated viral evolution due to excessively high viral mutation rate and alteration in cellular tropism (Grossman *et al.*, 2006).

Damage to lymphoid tissue occurs as a result of thymic dysfunction, transforming growth factor- β -dependent fibrosis and alterations in lymphoid follicle architecture (He *et al.*, 2006). This affect blood and tissue B cells by inducing early class switching in

polyclonal B cells, massive B cell apoptosis, and loss of germinal centers in lymphoid tissue (He *et al.*, 2006) and leads to production of inflammatory mediators at the expense of the development of immunodeficiency (He *et al.*, 2006).

2.4.3 Immunity to HCV infection

After an HCV infection, the innate immune response is important for controlling viral replication with the adaptive immune response peaking weeks after infection (Lloyd *et al.*, 2007). The innate immune system recognizes both single-stranded and double-stranded HCV RNA through its pattern recognition receptors, Toll like receptor 3 (TLR3) on the hepatocytes cell surface and retinoic-acid-inducible gene I (RIG-I) in the cytoplasm of the hepatocytes activating cascade causing the induction of type 1 interferons such as interferon α and β (Lloyd *et al.*, 2007).

The natural killer cells (NK) lyses infected cells, produce interferon- γ (IFN- γ) to control viral replication, and directing inflammatory cells to HCV-infected hepatocytes (Lloyd *et al.*, 2007).

The onset of the cellular immune response is clinically detected by a rise in serum transaminases marking immune-mediated liver injury and CD4⁺ and CD8⁺ T cell response lead to HCV clearance (Rehermann *et al.*, 2005). The CD4⁺ response elicits Th1 cytokines (Rehermann *et al.*, 2005).

2.4.4 Immunity to HBV infection

Experimentally it was observed Hepatitis B e Antigen (HBeAg) suppress the hepatitis antibody and T-cell response to Hepatitis B c Antigen (HBcAg) in adult T-cell receptor transgenic mice functioning either to delete or anergize (Reignat *et al.*, 2002). The HBcAg/HBeAg cross-reactive the T cells, depending on their functional avidity for the tolerogenic epitope (Reignat *et al.*, 2002). The HBeAg may suppress immune

elimination of infected cells by HBcAg-specific T cells and, thereby, contribute to viral persistence in chronically infected adults (Reignat *et al.*, 2002). The hepatitis B surface antigen (HBsAg) might also suppress immune elimination of infected cells by functioning as a high-dose tolerogen, (Reignat *et al.*, 2002).

HBV X protein, a transcriptional transactivator is required for initiation of infection, can inhibit cellular proteasome activity when it is over expressed and has the potential to inhibit antigen processing and presentation (Reignat *et al.*, 2002). The cytotoxic T-lymphocyte (CTL) response clears viral infections by killing infected cells by entering the liver and recognize viral antigen, triggering two events, apoptosis of the hepatocytes that are physically engaged by the CTLs and secretion of IFN- γ (Moriyama *et al.*, 1990). The non cytopathically inhibits HBV gene expression and replication in the rest of the hepatocytes by preventing the assembly of the RNA-containing capsids in the cytoplasm in a proteasome and kinase-dependent process (Moriyama *et al.*, 1990).

During the process, the viral nucleocapsids disappear from the cytoplasm of the hepatocytes, and the viral RNAs are destabilized in the nucleus, with hepatocytes remain healthy, as a result, all of the viral gene products and virions decrease in the liver and the serum inhibiting further viral spread (Guidotti *et al.*, 1999). This antiviral process is completely blocked by the administration of antibodies to IFN- γ before the CTLs are injected indicating that IFN- γ production by the CTLs is responsible for the noncytopathic antiviral effect (Guidotti *et al.*, 1999).

2.5 Chemokines and their role during infection

Chemokines are a family of small cytokines/proteins (8-10 Kd) secreted by cells (McDermott *et al.*, 2000). They are chemo attractant cytokines, small peptides and serve to regulate chemotaxis or the movement of cells, adhesion and the activity of the cells but not the proliferation of immune responsive cells and tissues (McDermott *et al.*,

2000). They are soluble factors, increasingly recognized to have a much broader range of functions, e.g. chemokines like IL-8, macrophage inflammatory protein (MIP)-1 α and Monocyte chemo attractant protein-1 (MCP)-1 have been shown to be inhibitors of hematopoietic progenitor cell proliferation (McDermott *et al.*, 2000). The proteins are classified based on their structural characteristic and they possess amino acids that assist in creating their 3-D or tertiary structure (McDermott *et al.*, 2000).

2.5.1 Types of chemokines

Chemokines can be classified based on the number and location of conserved cysteines: C, CC, and CXC (Murphy *et al.*, 1996). The chemokine receptors are grouped into families on the basis of the chemokine ligands they bind: CC, CXC, or both (Murphy *et al.*, 1996). The subfamily usually contain four cysteines (C4-CC chemokines), but a small number of CC chemokines possess six cysteines (C6-CC chemokines). The C6-CC chemokines include CCL1, CCL15, CCL21, CCL23 and CCL28 (Liu *et al.*, 1999). CXC chemokines have been described in mammals and are subdivided into two categories, those with a specific amino acid sequence (or motif) of Glutamic acid-Leucine-Arginine (or ELR) immediately before the first cysteine of the CXC motif (ELR-positive), and those without an ELR motif (ELR-negative) (Liu *et al.*, 1999). C chemokines indicates that the C chemokines (or γ chemokines) unlike all other chemokines have has only two cysteines; one N-terminal cysteine and one cysteine downstream (Mc Dermott, 2000) and demonstrates that the CX3C chemokines (or δ -chemokines) have three amino acids between the two cysteines (Mc Dermott, 2000).

2.5.2 Chemokine receptors

Chemokine receptors are cell surface proteins that bind small peptides called chemokines (Murphy *et al.*, 2006). Some receptors are promiscuous, while others are selective in terms of ligand binding. The receptors are widely distributed on

hematopoietic and other cells, but the Duffy antigen of erythrocytes (DARC) is the only member expressed on cells of erythroid lineage (Murphy *et al.*, 2006). The characteristic feature of all chemokine receptors is a serpentine 7 transmembrane-spanning domain structure, which is shared with other receptors; e.g., the rhodopsin and the thyrotrophin receptors (Murphy *et al.*, 2006).

The extracellular portions of chemokine are involved in chemokine binding, while intracellular portions are involved in cell signaling (Murphy *et al.*, 1996). The effect of receptor-ligand interactions are mediated through G-protein coupled interactions; results in alterations in cell function such as activation, motion, or migration, usually along a chemokine concentration gradient; and varies depending on the chemokine bound and the cell type (Murphy *et al.*, 1996).

Some chemokine receptors have a role in infectious disease susceptibility or pathogenesis, and several viruses (Epstein-Barr virus, cytomegalovirus, and Herpes virus) contain functional homologues of human chemokine receptors, which suggest that the viruses may use these receptors to subvert the effects of host chemokines (Appay *et al.*, 2000).

2.5.3 Role played by chemokines in infection

Chemokines and their receptors mediate inflammation and tissue damage in autoimmune disorders (Kim *et al.*, 2007). Some chemokines have roles in development; they promote angiogenesis, growth of new blood vessels, or guide cells to tissues that provide specific signals critical for cellular maturation (Kim *et al.*, 2007). T helper (Th)1 immune responses dominate in the HCV infected liver (Shields *et al.*, 1999) and intrahepatic T cells express chemokine receptors associated with Th1 responses including Chemokine Receptor type 3 (CXCR3), Chemokine Receptor type 6 (CXCR6), CC receptor 1 (CCR1) and CC receptor 5 (CCR5) (Heydtmann *et al.*, 2006).

The distribution of chemokines within the liver compartmentalizes, enables recruitment to different anatomical sites; CC receptor 5 (CCR5) recruits lymphocytes to portal tracts whereas Chemokine Receptor type 3 (CXCR3) is essential for recruitment into the parenchyma via sinusoids and Chemokine Receptor type 6 (CXCR6) localizes cells to infected (Guidotti *et al.*, 2001). Viral infection of hepatocytes activates chemokine secretion resulting in the recruitment of innate immune cells including NK and NKT cells which sustain local IFN γ production (Guidotti *et al.*, 2001). Hepatitis C virus (HCV) core protein NS4A, NS4B and NS5A can all induce chemokine secretion in vitro and some of these chemokines subvert the anti-viral immune response (Guidotti *et al.*, 2001). Type 1 helper T cell (Th1) associated CXC chemokine receptor 3 (CXCR3) and CC-chemokine receptor 5 (CCR5) binding chemokines are detected in the peripheral blood approximately 2–8 weeks after initial infection with HCV (Thimme *et al.*, 2012). The chemokine production does not appear to dictate the outcome of acute infection; it represents a target in HCV evasion with implications for effector cell recruitment and viral elimination (Guidotti *et al.*, 2001). HCV may interfere with DC trafficking by modulating chemokine expression and thus prevent efficient antigen presentation (Thimme *et al.*, 2012).

2.6 The role RANTES in HIV infection

Regulated upon Activation Normal T cell Expressed and Secreted (RANTES) (figure 5) is a chemokine secreted by activated T cells during an infection (Scall *et al.*, 1990). It has effects on recruitment and attraction of monocytes, memory T cells, basophils, neutrophils and natural killer cells to the sites of infection (Scall *et al.*, 1990).

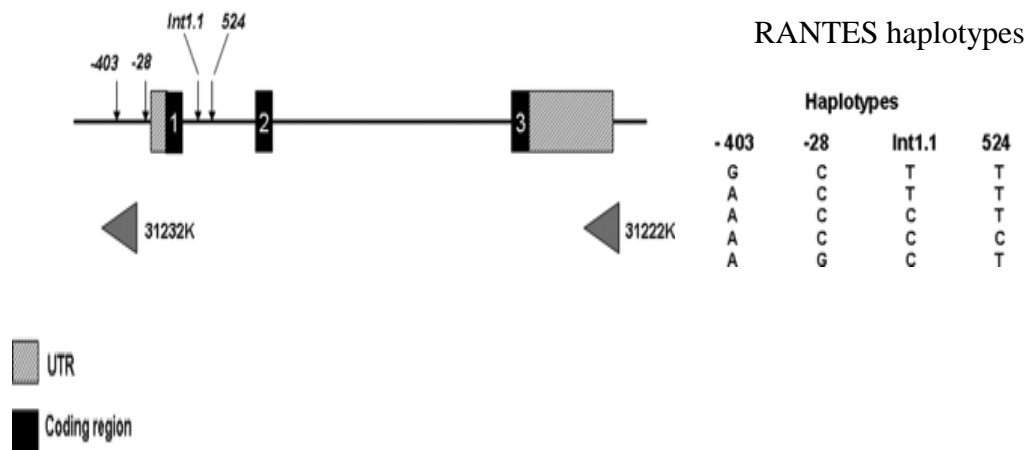

Figure 2.1: Schematic diagram of RANTES gene

Location of the coding regions (■), untranslated regions (▨) and polymorphisms.

Source; Scall *et al.*, 1990

RANTES gene is located in the long arm of chromosome 17. The gene spans approximately 7.1 Kb and is composed of three exons and two introns. The RANTES protein comprises 91 amino acids including 23 residue leader sequences. A mature protein is basic with a molecular weight 7847 Daltons (Nelson *et al.*, 1993). It is a chemo attractant that causes degranulation of basophils, respiratory burst in eosinophils and stimulation of T cell proliferation. It plays a role in immune regulatory function, auto immune disorder, inflammatory diseases and an important factor in the suppression of HIV infection, competing with the virus in infiltration T cell (Nelson *et al.*, 1993).

RANTES is released by cytotoxic T lymphocytes (CTL), and is a potent chemo attractant factor for monocytes and T cells, also known for its ability to suppress HIV infection (Appay *et al.*, 2000). At micromolar concentration, RANTES is able to activate leukocytes, and, paradoxically, to prevent enhancement HIV infection in vitro. These latter properties are dependent on its ability to self-aggregate (Appay *et al.*, 2000).

At higher concentrations (micromolar and above), a protein tyrosine kinase (PTK)-mediated signal is triggered, leading to cell activation. RANTES-induced activation appears not to be confined to T cells, but dual signalling pathways may also be induced in monocytes and neutrophils (Appay *et al.*, 1999). RANTES has ability to self-aggregate, forming multimers at high concentration (Trikola *et al.*, 1999). Non-aggregating RANTES also fails to enhance HIV infection at high concentration (Trikola *et al.*, 1999). Disaggregated RANTES also acts as an inhibitor and the presence of erythrocytes inhibits RANTES-induced activation (Appay *et al.*, 1999).

CHAPTER THREE

MATERIALS AND METHODS

3.1 Study site

The study was carried out using blood samples obtained from the Centre for Biotechnology Research and Development (CBRD) laboratory in the Kenya Medical Research Institute (KEMRI), Nairobi Kenya. The blood samples prior to collection should have been stored at least a maximum of three days. The blood samples were initially obtained under a National HIV initiative project that monitored CD4 levels in HIV positive patients. All samples from the study sites were transported to Kenya Medical Research Institute (KEMRI), Centre for Biotechnology Research and Development (CBRD) for analysis.

3.2 Study design

The study was a cross-sectional; blood samples were obtained from any patient who visited the health center is registered under the health center. Those referred to the VCT and found positive were recruited in to the project

3.3 Sampling plan

3.3.1 Inclusion criteria

Blood samples were from HIV positive individuals above 18 years. The samples should be anticoagulated with EDTA.

3.4 Sample size determination

Sample size was determined using standard statistical formula (Cochran, 1963)

$$n = Z^2 pq / d^2$$

where;

$$Z^2 = 1.96$$

P=8% (National prevalence of Hepatitis, WHO 2008)

$$q = (1-p) = 1 - 8/100 = 0.92$$

$$d = (0.05)^2$$

$$n = (1.96)^2 \times 0.08 \times 0.92 \times (0.05)^2 = 113.09 = 113$$

Sample size was increased to 226 to increase chances of obtaining Hepatitis virus and also for full utilization of the test kits.

3.5 Sample collection

Study was part of an ongoing bigger project where blood samples were collected by trained personnel recognized and registered at the health center facilities. Samples were transported to KEMRI, CBRD laboratory for further analysis.

3.6 Analysis of CD3, CD4 cell counts

The Absolute CD4+, CD3+ counts was accomplished with cytometric method using FACS caliber machine of Becton Dickinson (CA, USA). All the reagents were from Becton Dickinson (CA). Approximately 20 µl of antibodies (CD3-FITC/CD4-PE/CD45-

PerCP) were added into different TruCOUNT tubes then 50 µl of whole blood was added into each TruCOUNT tube. The mixtures were gently vortexed at room temperature (18°C–25°C) and incubated in the dark for 20 minutes. To each tube 450 µl 1×FACS lysing solution (Dilute 10×FACS lysing solution with distilled water) was added. The mixtures were incubated at 20°C–25°C in the dark for 15 minutes, then run within 24 hours, according to the manufacturer's instructions.

3.7 Determination of differential count

The Absolute counts of lymphocytes, neutrophils, monocytes, eosinophils, basophils and Platelets were accomplished with Abacus 5 automated Blood Analyzer technologies of DIATRON MI PLC GROUP (Budapest,Hungary) employing cytometric methods. All reagents were from Diatron group. Twenty litres isotonic diluents (Diatro Dill Diff), one litre haemolysing agent (Diatro lyse Diff), one litre cleaner (Diatro cleaner) was introduced into the machine with 25 µl whole blood added then run within 1 hour, according to the manufacturer's instructions.

3.8 Processing of dried blood spot (DBS) forHIV-1diagnosis and DNA extraction

Blood samples were aseptically spotted on five specified slot on sterile labelled whatman filter paper. Each spot contained 15 µl of blood sample, dried overnight and packaged in sterile zip lock paper with desiccants, according to the manufacturer's instructions.

3.9 Separation of whole blood

Blood samples in EDTA vacutanier tubes were centrifuged at 5000 XG for 5 minutes. Plasma supernatant was aspirated and placed into a sterile labeled vial and stored at -80°C for preservation till further use in HCV and HBV diagnosis.

3.10 HCV diagnosis

Serotyping of HCV was done by use of HCV ELISA -MUREX anti-HCV (ABBOTT Diagnostics Division Murex Biotech Limited Dartford, UK) where 20 µl plasma antibodies were captured on a 96 antigen (purified HCV antigens) coated wells. The plates were coated with negative and positive control wells. During the course of the first incubation any serotype-specific anti-HCV antibodies in the sample bound to the immobilized antigens.

Following three washing steps to remove unbound material, the captured anti-HCV antibodies were incubated with peroxidase conjugated monoclonal anti-human immunoglobulin G. Excess conjugate was removed after second incubation. Bound enzyme were detected by the addition of a solution containing 3, 3', 5, 5'-tetramethylbenzidine (TMB) and hydrogen peroxide. The enzyme reaction was terminated with sulphuric acid and results determined photometrically using spectrophotometer at wavelength of 450 nanometer using Elisa Plate Reader (**Bioline Technologies**). The amount of colour in the wells was directly related to the concentration of specific antibody in the sample and the result were expressed as the ratio of the optical density of the test sample to that of a kit control according to the manufacturer instructions.

3.11 HBV diagnosis

Serotyping for HBV was done by use of HBV Elisa-Hepanostika HBsAg Ultra, Hepanostika® HBsAg Ultra (bioMérieux Diagnostics, Lyon, France). Approximately 25 µl plasma antibodies were captured on a 96 antigen (purified HBV antigens) coated well plate. The Plate was coated with negative controls and positive control wells.

After the first incubation serotype specific anti-HBV antibodies in the sample bound to the immobilized antigens. Following three washing steps to remove unbound material,

the captured anti-HBV antibodies were incubated with conjugated solution and excess conjugate was removed after second incubation. Bound enzyme was detected by the addition of a tetramethylbenzidine (TMB) solution and hydrogen peroxide.

The enzyme reaction was terminated with sulphuric acid and the results were determined photometrically using spectrophotometer at wavelength of 450 nanometer using Elisa Plate Reader (**Bioline Technologies**). The amount of colour in the wells was directly proportional to the concentration of specific antibody in the sample the result were expressed as the ratio of the optical density of the test sample to that of a kit control according to the manufacturer instructions.

3.12 HIV confirmation

HIV-1 infection was determined by The COBAS[®] AmpliPrep/COBAS[®] TaqMan (Roche Molecular Diagnostics, Pleasanton, California[®]). The COBAS[®] AmpliPrep/COBAS[®] TaqMan[®] HIV-1 Test was based on three major processes, specimen preparation to isolate HIV-1 RNA; reverse transcription of the target RNA to generate complementary DNA (cDNA), and simultaneous PCR amplification of target cDNA and detection of cleaved dual-labeled oligonucleotide probe specific to the target.

The COBAS[®] AmpliPrep/COBAS[®] TaqMan[®] HIV-1 Test permitted automated specimen preparation followed by automated reverse transcription, PCR amplification and detection of HIV-1 target RNA and HIV-1 Quantitation Standard (QS) Armored RNA. The Master Mix reagent (Roche Molecular Diagnostics) contained primers and probes specific for both HIV-1 RNA and HIV-1 QS RNA. Detection of amplified DNA was performed using a target-specific and a QS-specific dual-labeled oligonucleotide probe that permit independent identification of HIV-1 amplicon and HIV-1 QS amplicon.

The quantitation of HIV-1 viral RNA was performed using the HIV-1 QS that compensated the effects of inhibition, controls the preparation and amplification processes, allowing a more accurate quantitation of HIV-1 RNA in each specimen.

The HIV-1 QS was added to each of the specimen and carried through the specimen preparation, reverse transcription, PCR amplification and detection steps of cleaved dual-labeled oligonucleotide detection probes. The COBAS[®] TaqMan[®] Analyzer calculates the HIV-1 RNA concentration in the test specimens by comparing the HIV-1 signal to the HIV-1 QS signal for each specimen and control, and determines the HIV-1 RNA concentration for the specimens and controls according to the manufacturer instructions.

3.13 DNA extraction from dried blood spots (DBS)

DNA was extracted using QIAGEN (QIAGEN GROUP Kits © 2011 QIAGEN). Three out of the 5 dried blood spots (DBS) were punched in micro centrifuge tubes. Purification protocols was based on a modified alkaline lysis procedure using QIAamp[®] Mini spin column, followed by binding of the DNA to QIAGEN Anion-Exchange Resin under appropriate low-salt and pH conditions. RNA, proteins, dyes, and low-molecular-weight impurities are removed by a medium-salt wash. The DNA was eluted in a high-salt buffer and then concentrated and desalted by isopropanol precipitation. Results were obtained under manufacturer's instructions (QIAGEN GROUP Plasma KIT© 2011 QIAGEN). The DNA extract obtained was stored at -30⁰C until further use, according to the manufacturer instructions.

3.14 Polymerase Chain Reaction (PCR) of the RANTES G 28 polymorphism

RANTES G 28, a cytosine /guanine transversion at position 28 in human RANTES promoter was studied using following primers:

Forward: 5'-ACA GAG ACT CGA ATT TCC GGA-3'

Reverse: 5'- CCA CGT GCT GTC TTG ATC CTC -3'

Primers were obtained from (Eurofins MWG/ Operon Germany)

Extracted genomic DNA was thawed at room temperature. The sample DNA concentration of 0.5µl was amplified in a 25 µl reaction volume. Master Mix contained 2 µl magnesium chloride (MgCL₂), 2 µl deoxynucleotide triphosphate (dNTP) mix (Eppendorf[®], Germany), 0.3 µl of forward primer, 0.3 µl of reverse primer, 1 µl Polymerase chain reaction (PCR) buffer, 18 µl double distilled (DD) water and 0.5 ul Taq DNA polymerase (KEMRI). The PCR cycles were 94°C for 5 min followed by 35 cycles each of 94 ° C for 1 min, 62 ° C for 1 min and 72 ° C for 1 min. A final extension was 72 °C for 5 min. GeneAmp PCR (Polymerase chain reaction) machine (Applied Biosystems[®]).

A concentration 0.2µL of the amplified products and 0.2µL of the DNA ladder (Eppendorf[®], Germany), of 100 base pair were loaded to a 1.5% agarose gel, (Sigma[®], USA) and subjected to an electric current of 70 volts for 50 min and stained using ethidium bromide (Sigma USA) at concentration of 10 µl concentrated ethidium bromide in 100 µl Tris boric acetate buffer for 20 min. RANTES G 28 PCR products (amplicons) were separated by size fractionation on the agarose gel and bands visualised under a UV- transilluminator using 302 nm UV.

3.15 Data analysis

The data was entered in excel and analyzed using Statistical Package for the Social Sciences (SPSS) statistical software version 21. Pearson's correlation analysis was done to determine the correlation, prediction of occurrence and coefficients. Mean \pm standard deviation (Mean \pm SD) was also used for variables. Differences were considered significant when the p values were < 0.05 .

3.16 Ethical consideration

Blood samples were obtained from an ongoing national study project ,CD4 testing a national testing service for HIV infected individuals served at department of Center for biotechnology research development (CBRD) in Kenya Medical Research Institute (KEMRI), established in 2008.The Ethical Research Committee (ERC) and Scientific research committee (SRC) of the Kenya Medical Research Institute (KEMRI) approved the protocol for the ongoing national study project and informed consent was obtained from each participant. Sample collection was done by qualified trained personal and the proper techniques were followed to minimize and reduce any risk thereof. Consideration employed involved; Anonymity: Samples obtained were coded and there was no link whatsoever with identity of the sample to the identity of a person. Results are therefore anonymous and unlinked.

CHAPTER FOUR

RESULTS

4.1 Seroprevalance of HIV-1/ HIV-1/HBV, HIV-1/HCV and HIV-1/HBV/HCV co infections

Out of 226 HIV-1 positive blood samples, 199 (88%) were positive for HIV-1 only, 7 (3%) had HBV antibody, 18(8%) had HCV antibody and 2 (0.4%) had both HBV and HCV antibody (Figure 4.0).

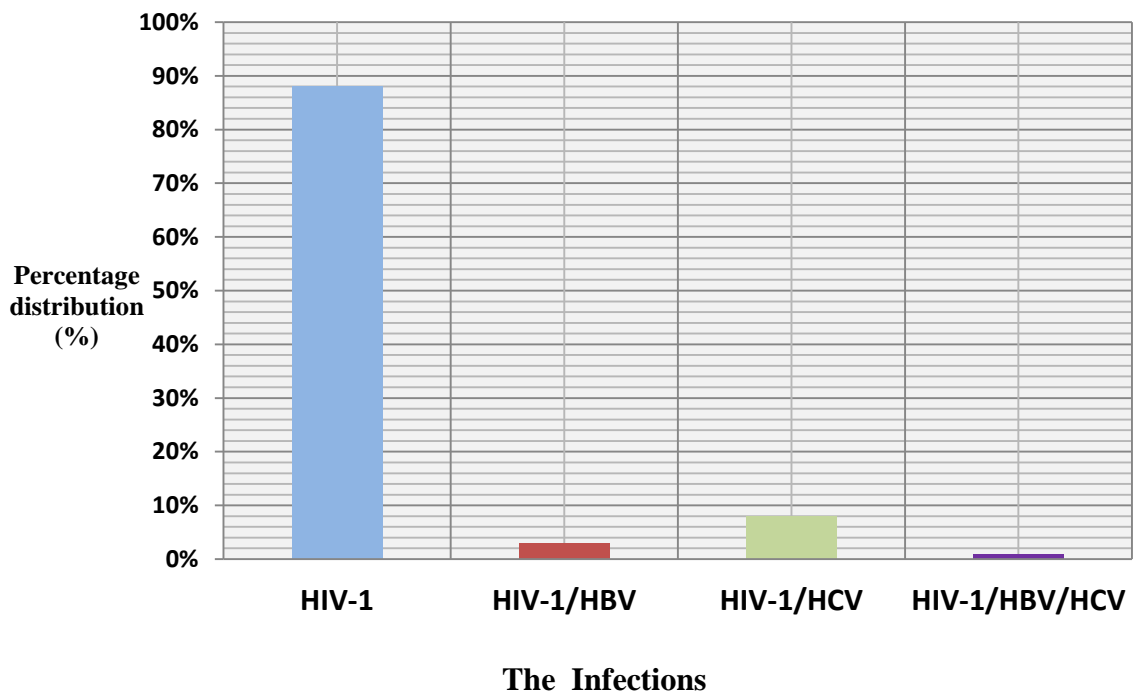

Figure 4.0: Seroprevalance of HIV-1 infection, HIV-1/HBV, HIV-1/HCV and HIV1/HBV/HCV co infections

4.2 The Mean levels of Leukocytes in presence of HIV-1, HIV-1/HBV, HIV-1/HCV and HIV-1/HBV/HCV co infections

Table 4.0: The mean distribution of CD3, CD4, absolute lymphocytes, neutrophils, monocytes, eosinophils, basophils and platelets in HIV-1 infection, HIV-1/HBV, HIV-1/HCV and HIV-1/HBV/HCV co infections

	CD3	CD4	Absolute lymphocytes	Neutrophils	Monocytes	Eosinophils	Basophils	Platelets
	mean ± SD	mean ± SD	mean ± SD	mean ± SD	mean ± SD	mean ± SD	Mean± SD	mean ± SD
HIV-1	1773 ±839	428±36 2	60±16	28.9± 16	7.5±4	2.6± 2.8	1.2 ±1.2	211±75
HIV-1/HBV	1367 ±499	288± 150	57.8 ± 17	28.8±19	9.8 ±5.9	2.6± 3.7	0.83±1.3	191±56
HIV-1/HCV	1863 ± 413	451 ± 256	57.9 ±13	29±12	10±6	1.58 ±1.1	6.9±1.37	210±70
HIV1/HBV/HCV	1675 ± 543	226 ± 79	48.6±2.6	35±14	14±11	2.2±0.8	<1± <1	216± 114
Normal range	690-2250 cells/mm ³	500-1000 cells/m ³	25-45 cells/m ³	45-75 cells/mm ³	2-10 cells/mm ³	1-6 cells/mm ³	1-2 cells/mm ³	150-450 cells/μl

The mean ± SD levels compared to reference ranges showed that the levels of CD3, monocytes, eosinophils and platelets in HIV-1 infection, HIV-1/HBV, HIV-1/HCV and HIV-1/HBV/HCV co infection were within normal range but the monocytes mean ± SD level in HIV-1/HBV/HCV co infection was high.

The CD4 and neutrophils mean \pm SD count in HIV-1 infection, HIV-1/HBV, HIV-1/HCV and HIV-1/HBV/HCV co infection were low while the absolute lymphocytes mean \pm SD count in HIV-1 infection, HIV-1/HBV, HIV-1/HCV and HIV-1/HBV/HCV co infections was high. The mean \pm SD levels of basophils was reduced in HIV-1/HBV but elevated in HIV-1/HCV co infection (Table 4.0).

4.3 Correlation between HIV-1/HBV, HIV-1/HCV and HIV-1/HBV/HCV co infections on leukocytes

4.3.1 Correlation between HIV-1/HBV co infection and CD3, CD4, absolute lymphocytes, neutrophils, monocytes, eosinophils, basophils and platelets

The correlation between HIV-1/HBV co infection and CD3, CD4⁺ T cells, absolute lymphocytes, neutrophils, monocytes, eosinophils, basophils and platelets was determined using correlation[®], coefficient and prediction on occurrence (R^2) (Table 4.1).

Table 4.1: Correlation between HIV-1/HBV co infection and CD3, CD4+ T cells, absolute lymphocytes, neutrophils, monocytes, eosinophils, basophils and platelets

	R	R ²	Co efficient	Sig.
CD3	.101	.010	-.101	.128
CD4	.105	.011	-.105	.117
Absolute lymphocytes	.021	.000	-.021	.757
neutrophils	.000	.000	.000	.997
monocytes	.094	.009	.094	.161
eosinophils	.015	.000	.015	.819
basophils	.051	.003	-.051	.447
Platelet	.053	.003	-.053	.426

Dependent variable: HIV-1/HBV co infection P=0.05

A positive correlation was obtained between HIV-1/HBV co infection and CD3, CD4, absolute lymphocytes, monocytes, eosinophils, basophils and platelets ($R \geq 0.000$). No correlation was found between HIV-1/HBV co infection and neutrophils ($R=0.000$). The size effect of HIV-1/HBV co infection was to increase (coefficient-positive) with an additional effect of neutrophils, monocytes and eosinophils but reduce (coefficient negative) with an additional effect of CD3, CD4, monocytes, eosinophils and basophils. A positive prediction ($R^2 \geq 0.000$) on the occurrence of CD3, CD4, absolute lymphocytes, neutrophils, monocytes, basophils and platelets was in presence of HIV-1/HBV coinfection established but no prediction ($R^2 =0.000$) on occurrence of absolute lymphocytes, neutrophils and eosinophils during HIV-1/HBV co infection

4.3.2 Correlation between HIV-1/HCV co infection and CD3, CD4, absolute lymphocytes, neutrophils, monocytes, eosinophils, basophils and platelets

A correlation between HIV-1/HCV co infection and CD3, CD4, absolute lymphocytes, neutrophils, monocytes, eosinophils, basophils and platelets determined correlation(R), prediction on occurrence (R^2) and coefficient (Table 4.2).

Table 4.2: Correlation between HIV-1/HCV co infection and CD3, CD4+ T cells, absolute lymphocytes, neutrophils, monocytes, Eosinophils, basophils and platelets

	R	R^2	Co efficient	Sig.
CD3	.050	.002	.050	.456
CD4	.001	.000	-.001	.992
Absolute lymphocytes	.029	.001	-.029	.664
Neutrophils	.004	.000	-.004	.951
Monocytes	.232	.054	.232	.000
Eosinophils	.110	.012	-.110	.099
Basophils	.070	.005	-.070	.296
Platelets	.003	.000	.003	.970

P=0.05 Dependent variable: HIV-1 /HCV co infection

A positive correlation was obtained between HIV-1/HCV co infection and CD3, CD4⁺ T cells, absolute lymphocytes, neutrophils, monocytes, eosinophils, basophils and platelets ($R \geq 0.000$). The size effect of HIV-1/HCV co infection was to increase (coefficient - positive) with an additional effect of CD3, monocytes and platelets but reduce (coefficient -negative) with an additional effect of CD4, absolute lymphocytes, neutrophils, eosinophils and basophils.

A positive prediction ($R^2 \geq 0.000$) on the occurrence of CD3, CD4, absolute lymphocytes, neutrophils, monocytes, eosinophils, basophils and platelets was in presence of HIV-1/HCV co infection.

4.3.3 Correlation between HIV-1/HBV/HCV co infection and CD3, CD4, absolute lymphocytes, neutrophils, monocytes, eosinophils, basophils and platelets

A correlation between CD3, CD4, absolute lymphocytes, neutrophils, monocytes, eosinophils, basophils and platelets in HIV-1/HBV co infection, was determined by correlation (R), coefficient and prediction on occurrence (R^2) as shown in table 4.3

Table 4.3: Correlation between HIV-1/HBV/HCV co infection and CD3, CD4, absolute lymphocytes, neutrophils, monocytes, eosinophils, basophils and platelets

	R	R^2	Co efficient	Sig.
CD3	.196	.038	.196	.674
CD4	.434	.188	-.434	.331
Absolute lymphocytes	.251	.063	-.251	.588
Neutrophils	.315	.099	.315	.491
Monocytes	.243	.059	-.243	.599
Eosinophils	.099	.010	-.099	.832
Basophils	.805	.648	-.805	.029
Platelets	.691	.477	.691	.086

P=0.05 Dependent variable: HIV-1/HBV/HCV co infection

A positive correlation was found between HIV-1/HBV/HCV co infections and CD3, CD4, absolute lymphocytes, neutrophils, monocytes, eosinophils, basophils and platelets ($R \geq 0.000$). The size effect of HIV-1/HBV/HCV co infection was to increase (coefficient-positive) with an additional effect of CD3, neutrophils and platelets but reduce (coefficient-negative) with an additional effect of CD4, absolute lymphocytes, monocytes, eosinophils and basophils. A Positive prediction ($R^2 \geq 0.000$) on the occurrence of CD3, CD4, absolute lymphocytes, neutrophils, monocytes, eosinophils, basophils and platelets was in presence of HIV-1/HBV/HCV co infection.

4.4 RANTES G 28 activation during HIV-1, HIV-1/HB, HIV-1/HCV co infection

4.4.1 Confirmation of expression of RANTES G 28 through Gel-electrophoresis

for amplified RANTES G 28

The RANTES G 28 amplified products were run on an agarose gel, stained with ethidium bromide and visualized under UV (302 nm). Lane 1 - 10 represents amplified products and **M**, 100 base pair DNA ladder. The amplified product indicated a molecular weight of 200 bp. Sample 1 and 2 (HIV/HBV co infection), 3 and 4 (HIV-1/HCV co infection), 5 and 6 (HIV/HBV/HCV co infection), Sample 8-10 (HIV-1 infection) (Figure 4.1).

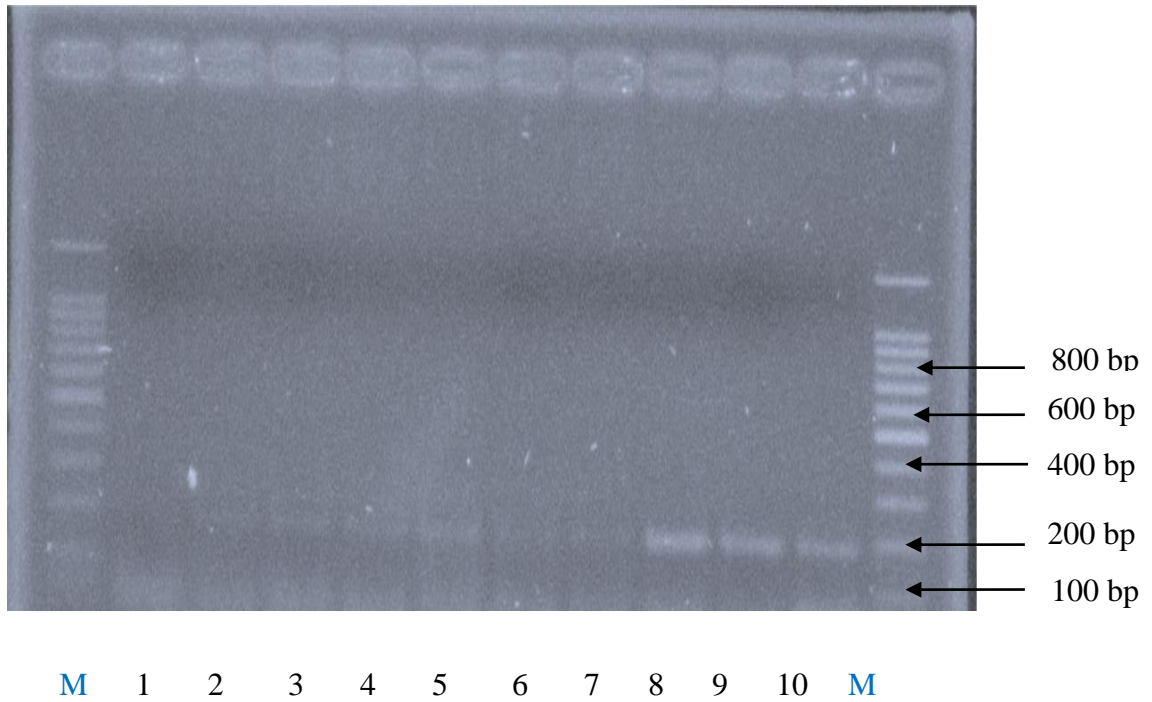

Figure 4.1: Gel-electrophoresis for amplified RANTES G 28

The PCR products bands on gel: (200 bp). M is the molecular marker while lanes 1-2 HIV-1/HBV, lanes 3-5 HIV-1/HCV co infection, lane 6-7 HIV-1/HBV/HCV co infection and lanes 8-10 HIV-1infection.

4.4.2 Frequency of RANTES G 28 genotypes among HIV-1-infected, HIV-/HCV, HIV-1/HBV and HIV-1/HBV/HCV co infection

RANTES G 28 was expressed in HIV infection, HIV-1/HBV, HIV-1/HCV and HIV-1/HBV/HCV co infections as shown in Table 4.4

Table 4.4: Frequency distribution of RANTES G 28 among HIV-1-infected, HIV-1/HCV and HIV-1/HBV co infection

	HIV-1(only) infection		HIV/HBV co infection		HIV/HCV co infection		HIV/HBV/HCV co infection
	RANTES	RANTES	RANTES	RANTES	RANTES	RANTES	RANTES
	G 28 positive	G 28 negative	G 28 positive	G 28 negative	G 28 positive	G 28 negative	G 28 positive
Frequency occurrence (No)	167	32	6	1	15	3	2
% Distribution	76.9	10	86	14	83	17	100

Out of the total number of blood samples, 76.9% (167) HIV-1 infected blood samples expressed RANTES G 28, HIV-1/HBV co infection 86% (6), HIV-1/HCV co infection 83% (15) and HIV-1/HBV/HCV co infection 100% (2)

4.4.3 Effect of RANTES G 28 on HIV-1, HIV-1/HBV, HIV-1/HCV and HIV-1/HBV/HCV co infections

The effect of RANTES G 28 on HIV-1 infection, HIV/HBV, HIV-1/HCV and HIV-1/HBV/HCV co infections was determined using correlation (R), coefficient and prediction on occurrence (R^2) (Table 4.5).

Table 4.5: Effect of RANTES G 28 on HIV-1 infection, HIV-1/HBV, HIV-1/HCV and HIV-1/HBV/HCV co infections.

	R	R ²	Co efficient	Sig
HIV-1	0.049	0.02	0.015	0.465
HIV-1/HBV	0.022	0.001	0.041	0.738
HIV-1/HCV	0.265	0.068	-0.329	0.000
HIV-1/HBV/HCV	0.040	0.002	0.152	0.552

Dependent variable: RANTES G 28 p=0.05

A positive correlation ($R \geq 0.000$) was obtained between RANTES G 28 and HIV-1 infection, HIV/HBV, HIV-1/HCV and HIV-1/HBV/HCV co infection. The size effect of RANTES G 28 with additional effect of HIV-1 infection, HIV/HBV, and HIV-1/HBV/HCV co infection was to increase (coefficient-positive) but reduced with an additional effect of HIV-1/HCV co infection (coefficient-negative). A positive prediction (R^2 positive) on RANTES G 28 occurrence was in presence of HIV-1 infection, HIV/HBV, HIV-1/HCV and HIV-1/HBV/HCV co infection.

4.4.4 Effect of RANTES G 28 on Leukocytes (CD3, CD4, absolute lymphocytes, neutrophils, monocytes, eosinophils, basophils and platelets)

The effect of RANTES G 28 on CD3, CD4⁺ T cells, absolute lymphocytes, neutrophils, monocytes, eosinophils, basophils and platelets was determined using correlation (R), coefficient and prediction on occurrence (R^2) (Table 4.6).

Table 4.6: Expression of RANTES G 28 on CD3, CD4, absolute lymphocytes, neutrophils, monocytes, eosinophils, basophils and platelets

	R	R ²	Co efficient	sig
CD3	0.021	0.000	0.021	0.752
CD4	0.021	0.000	0.021	0.757
Absolute lymphocyte	0.103	0.011	0.103	0.123
Neutrophils	0.106	0.011	-0.106	0.113
Monocytes	0.015	0.000	0.015	0.84
Eosinophils	0.009	0.000	-0.009	0.892
Basophils	0.079	0.006	-0.79	0.186
Platelets	0.003	0.000	0.003	0.960

Dependent variable - RANTES G 28 P=0.05

A positive correlation (R positive) was found between RANTES G 28 and CD3, CD4, absolute lymphocytes, monocytes, eosinophils, basophils and platelets ($R \geq 0.000$). The size effect of RANTES G 28 was to increase (coefficient-positive) with an additional effect of CD3, CD4, absolute lymphocytes, monocytes and platelets, but reduced (coefficient-negative) with an additional effect of eosinophils, basophils and neutrophils. A positive prediction (R² positive) on occurrence of RANTES G 28 was in presence of CD3, CD4, absolute lymphocytes, neutrophils, monocytes, eosinophils, basophils and platelets

4.5 Expression of RANTES G 28 in the presence of leukocytes (CD3, CD4, absolute lymphocytes, neutrophils, monocytes, eosinophils, basophils and platelets)

4.5.1 RANTES G 28 expression in presence of platelets infected with HIV-1 infection.

The level of platelets (cells/ μ l) at various cell distribution and with the expression of RANTES G 28 showed a mean \pm SD (214 ± 74.9) value, within normal range. No skewness was demonstrated (Figure 4.2).

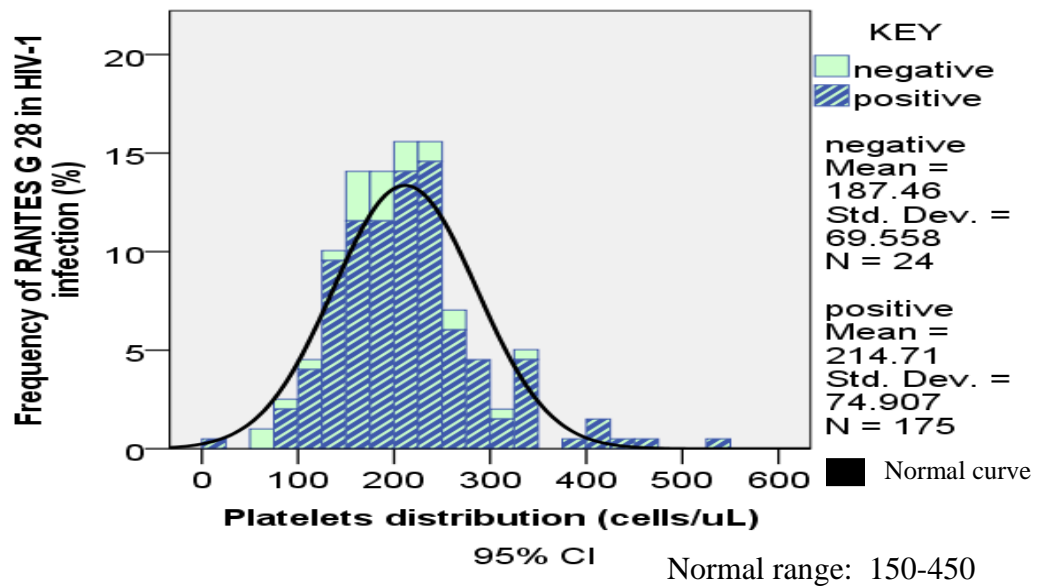

Figure 4.2: RANTES G 28 expression on the distribution of platelets in presence of HIV-1 infection showed expression of RANTES G 28.

Data shows the mean \pm SD of the maximum response of platelets to RANTES G 28 (**Negative**-samples negative for RANTES G 28. **Positive**- samples positive for RANTES G 28).

4.5.2 RANTES G 28 expression in the presence of basophils infected with HIV-1 infection.

The levels of basophils at various cells distribution (cell/mm³) in presence of RANTES G 28 expression showed a mean \pm SD (1.1 \pm 1.17) count, within the reference range. Moderate positive skewness was indicated (Figure 4.3).

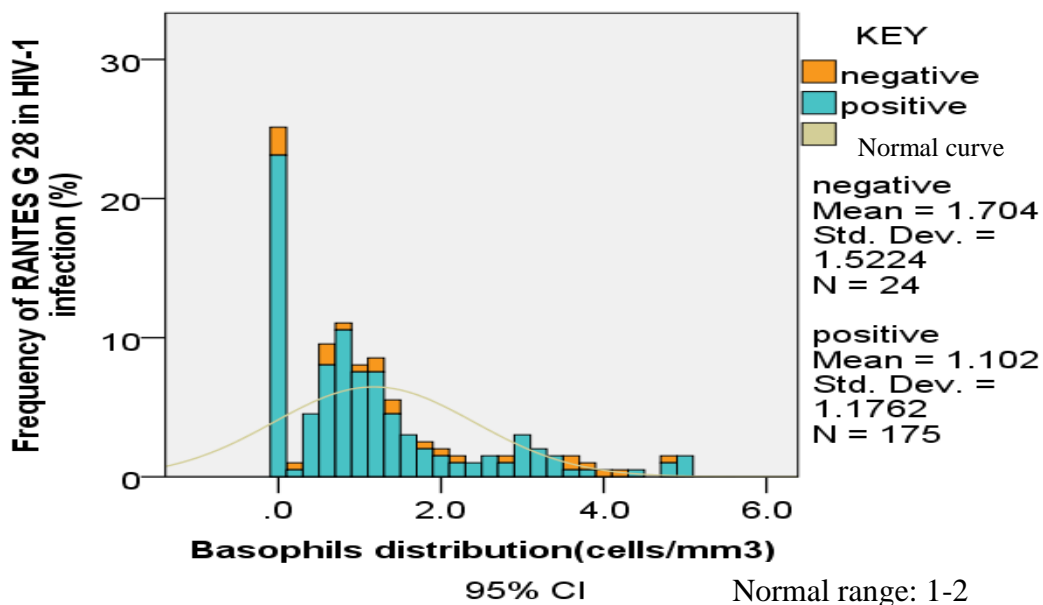

Figure 4.3: The expression of RANTES G 28 in presence basophils distribution (cell/mm³) infected with HIV-1.

Data shows the mean \pm SD of the maximum response of basophils to RANTES G 28 (**Negative**-samples negative for RANTES G 28. **Positive**-samples positive for RANTES G 28).

4.5.3 RANTES G 28 expression in presence of eosinophils infected with HIV-1 infection.

The expression of RANTES G 28 at various eosinophils (cells/mm³) distribution showed a mean \pm SD (2.56 \pm 2.8) count, within normal range. Positive skewness was demonstrated as shown in figure 4.4

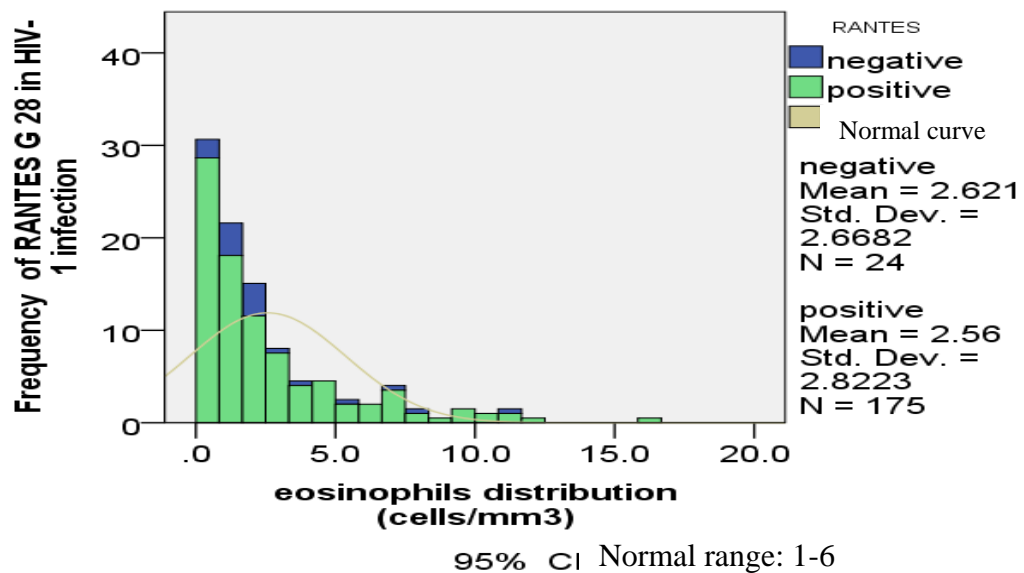

Figure 4.4: The expression of RANTES G 28 on eosinophils distribution (cell/mm³) infected with HIV-1 infection.

Data shows the mean \pm SD of the maximum response of eosinophils to RANTES G 28 (**Negative** -samples negative for RANTES G 28. **Positive** -samples positive for RANTES G 28).

4.5.4 RANTES G 28 expression in presence of monocytes infected with HIV-1 infection

The levels of monocytes at various cell distributions (cells/mm³) and with the expression of RANTES G 28 showed a mean \pm SD (7.7 ± 3.76) value it was within normal range. Moderate positive skewness was demonstrated as shown in figure 4.5.

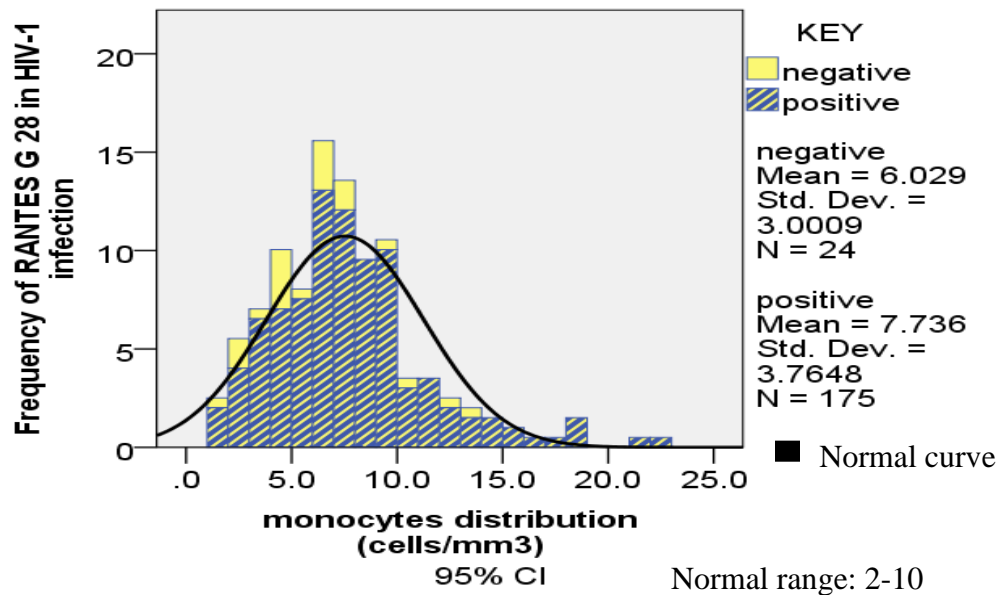

Figure 4.5: The expression of RANTES G 28 in presence monocytes distribution (cell/mm³) infected with HIV-1 infection.

Data shows the mean \pm SD of the maximum response of monocytes to RANTES G 28 (**Negative**-samples negative for RANTES G 28. **Positive**-samples positive for RANTES G 28).

4.5.5 RANTES G 28 expression in presence neutrophils infected with HIV-1 infection

The expression of RANTES G 28 at various levels of neutrophils distribution (cells/mm³) showed a mean \pm SD (28 \pm 15.6) value, it was within normal range. Moderate positive skewness was indicated as shown in figure 4.6.

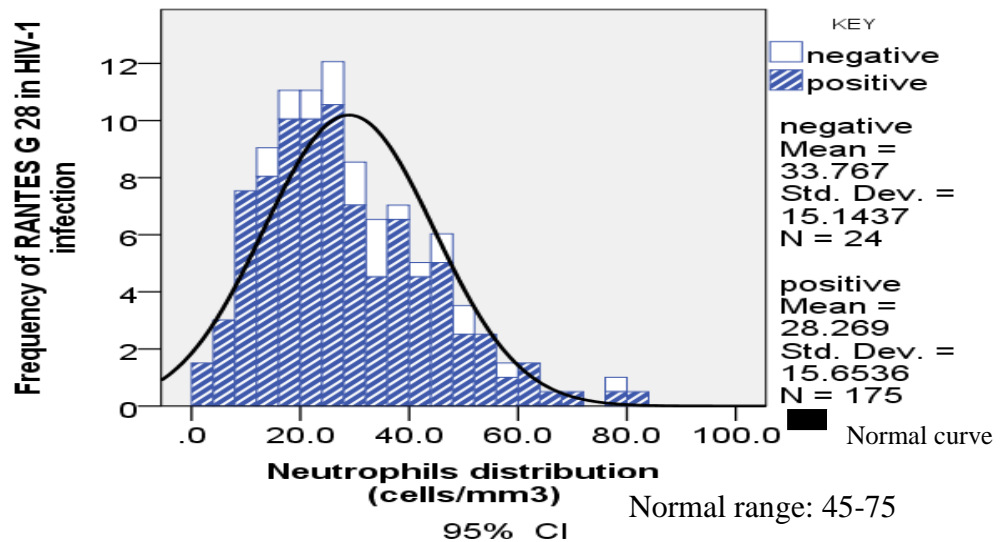

Figure 4.6: Expression of RANTES G 28 on neutrophils distribution (cell/mm³) infected with HIV-1 infection.

Data shows the mean \pm SD of the maximum response of neutrophils to RANTES G 28. (**Negative**-samples negative for RANTES G 28. **Positive**-samples positive for RANTES G 28).

4.5.6 RANTES G 28 expression on absolute lymphocytes infected with HIV-1 infection

At various cell distributions of absolute lymphocytes (cells/mm³) and with the expression of RANTES G 28, a mean \pm SD (59.9 \pm 15.8) value above reference range was demonstrated. Moderate negative skewness was indicated (Figure 4.7).

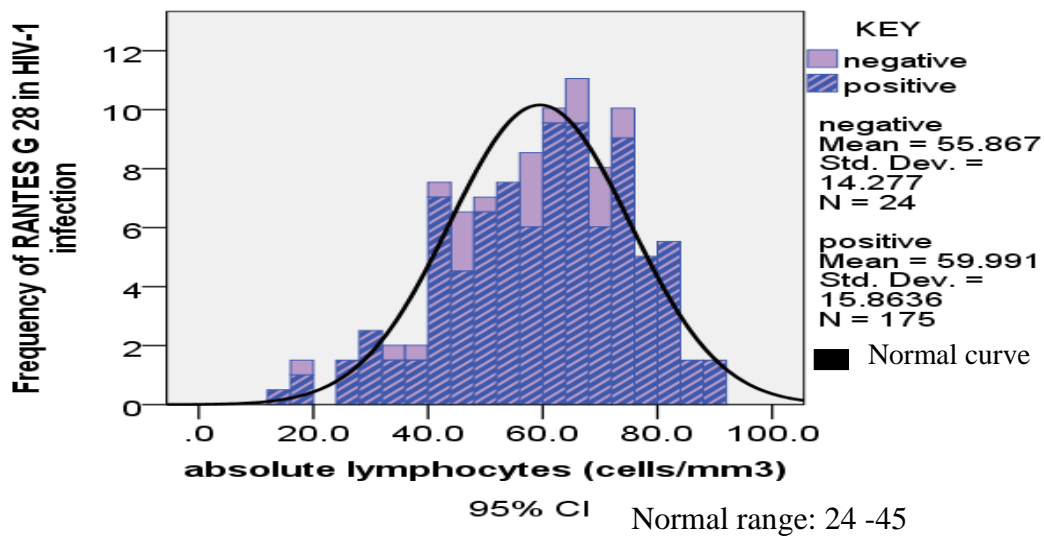

Figure 4.7: Expression of RANTES G 28 on absolute lymphocytes infected with HIV-1 infection.

Data shows the mean \pm SD of the maximum response of absolute lymphocytes to RANTES G 28 (**Negative**-samples negative for RANTES G 28. **Positive**-samples positive for RANTES G 28).

4.5.7 RANTES G 28 expressions in presence of CD4 infected with HIV-1infection

The expression of RANTES G 28 at various cell distribution of CD4 (cells/mm³), showed a mean \pm SD (474 \pm 372.6) count, below the normal range. A moderate positive skewness was indicated as shown in figure 4.8.

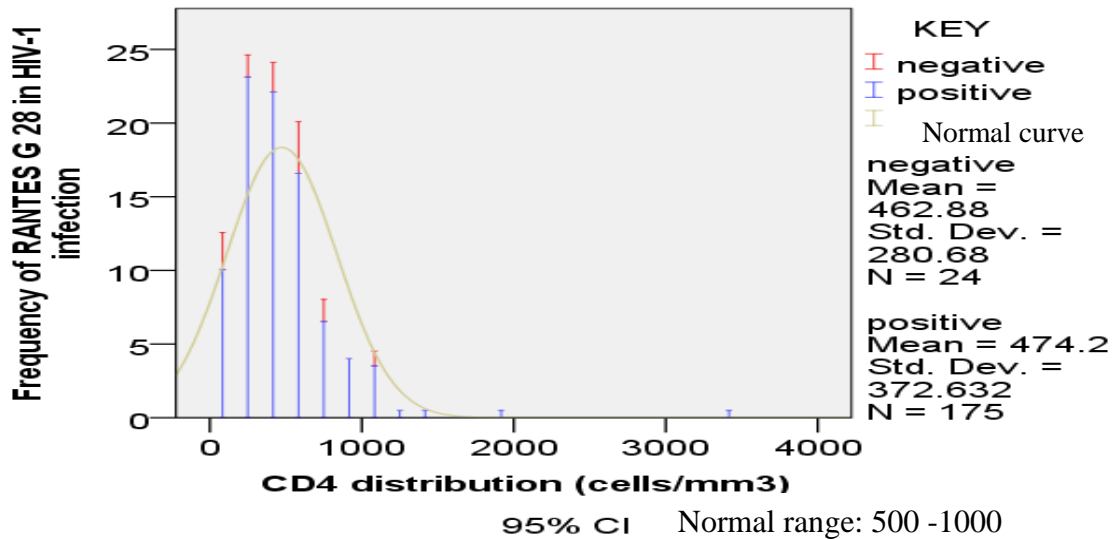

Figure 4.8: Expression of RANTES G 28 on CD4 distribution (cell/mm3) infected with HIV-1 infection.

Data shows the mean \pm SD of the maximum response of CD4 to RANTES G 28. (**Negative**-samples negative for RANTES G 28. **Positive**-samples positive for RANTES G 28).

4.5.8 RANTES G 28 expressions in presence of CD3 infected with HIV-1 infection

The expression of RANTES G 28 at various cell distribution of CD3 (cells/mm3) showed a mean \pm SD (1778 \pm 828) count within normal range. Moderate positive skewness was demonstrated as shown in figure 4.9.

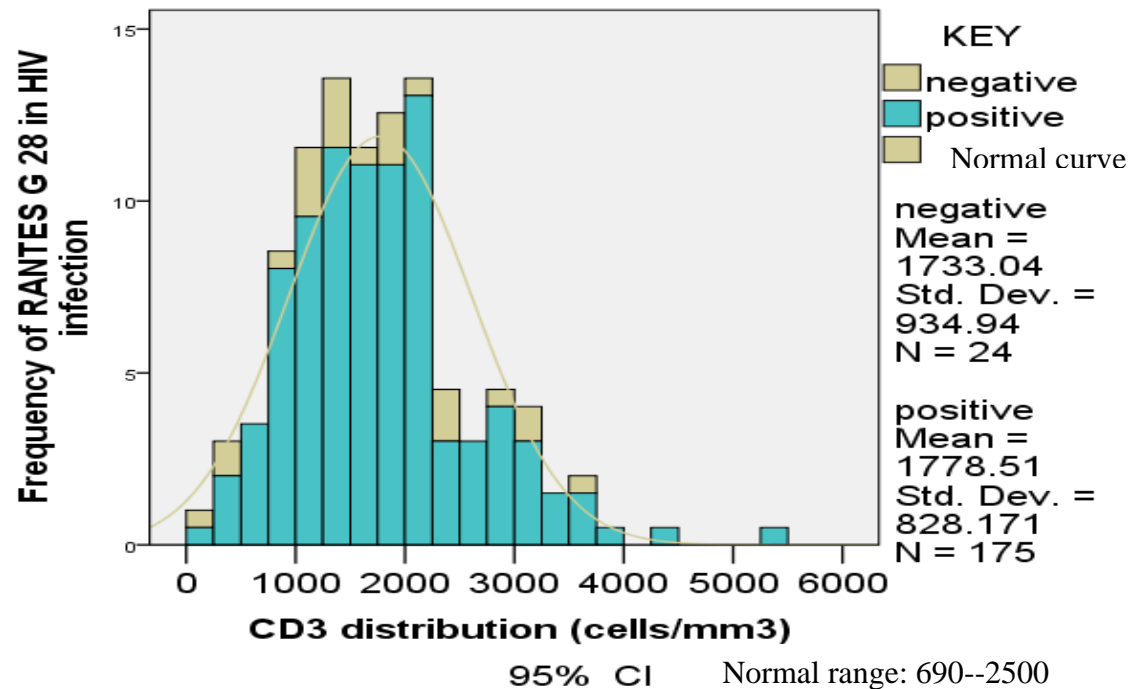

Figure 4.9: Expression of RANTES G 28 on CD3 distribution (cell/mm3) infected with HIV-1 infection.

Data showed the mean \pm SD of the maximum response of CD3 to RANTES G 28. (**Negative**-samples negative for RANTES G 28. **Positive**-samples positive for RANTES G 28).

4.6 Expression of RANTES G 28 in presence of HIV-1/ HBV co infection

4.6.1 RANTES G 28 expression in presence of platelets infected with HIV-1/HBV co infection:

The expression of RANTES G 28 at various cells distribution of platelets (cells/mm3) showed a mean \pm SD (196 ± 58) count it was within reference range. No skewness was indicated as shown in figure 4.10

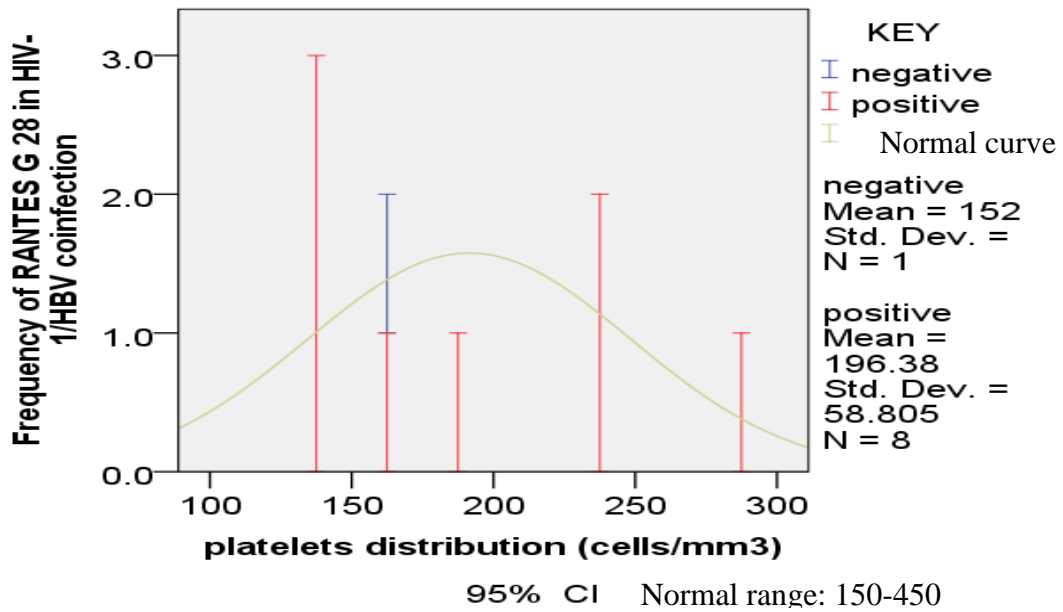

Figure 4.10: Expression of RANTES G 28 on platelets distributions (cells/mm³) infected with HIV-1/HBV co infection.

Data shows the mean \pm SD of the maximum response of platelets to RANTES G 28. (**Negative**-samples negative for RANTES G 28. **Positive** -samples positive for RANTES G 28).

4.6.2 RANTES G 28 expression in presence of basophils infected with HIV-1/HBV co infection

The expression RANTES G 28 at various cell levels of basophils (cell/mm³) showed a mean \pm SD (1773 \pm 839) that was within normal range. Positive skewness was indicated as shown in figure 4.11.

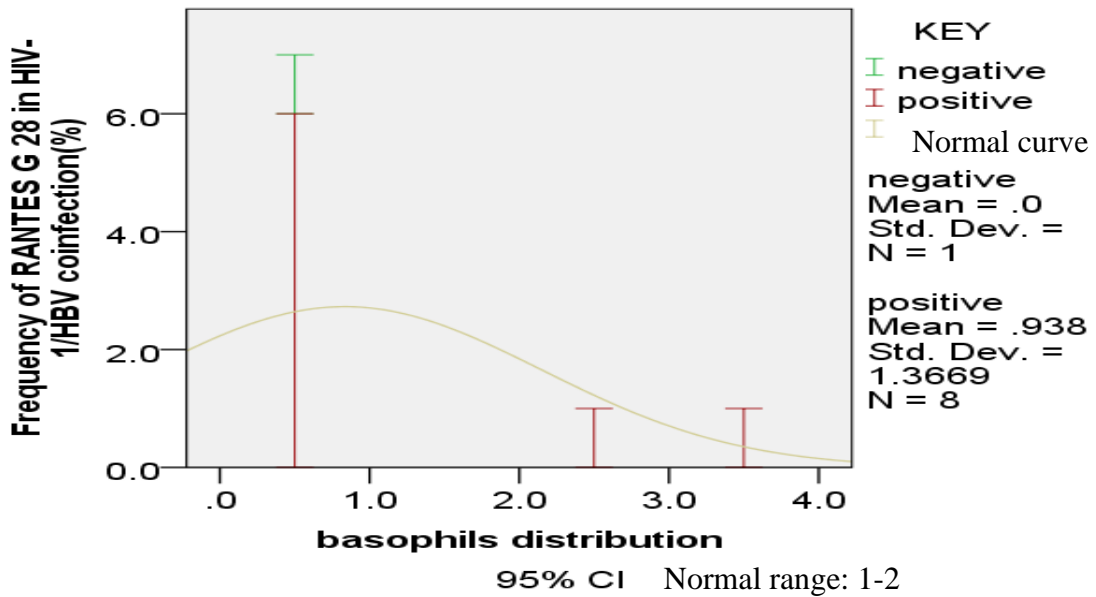

Figure 4.11: Expression of RANTES G 28 in presence of basophils infected with HIV-1/HBV co infection.

Data represent the mean \pm SD of the maximum response of basophils to RANTES G 28. (**Negative**-samples negative for RANTES G 28. **Positive** -samples positive for RANTES G 28).

4.6.3 RANTES G 28 expression in presence of monocytes infected with HIV-1/HBV co infection.

At various levels of monocytes distribution (cells/mm³) and with the expression of RANTES G 28, a mean \pm SD (8.9 \pm 5.7) value was shown and it was within normal range. Moderate positive skewness was indicated (Figure 4.12)

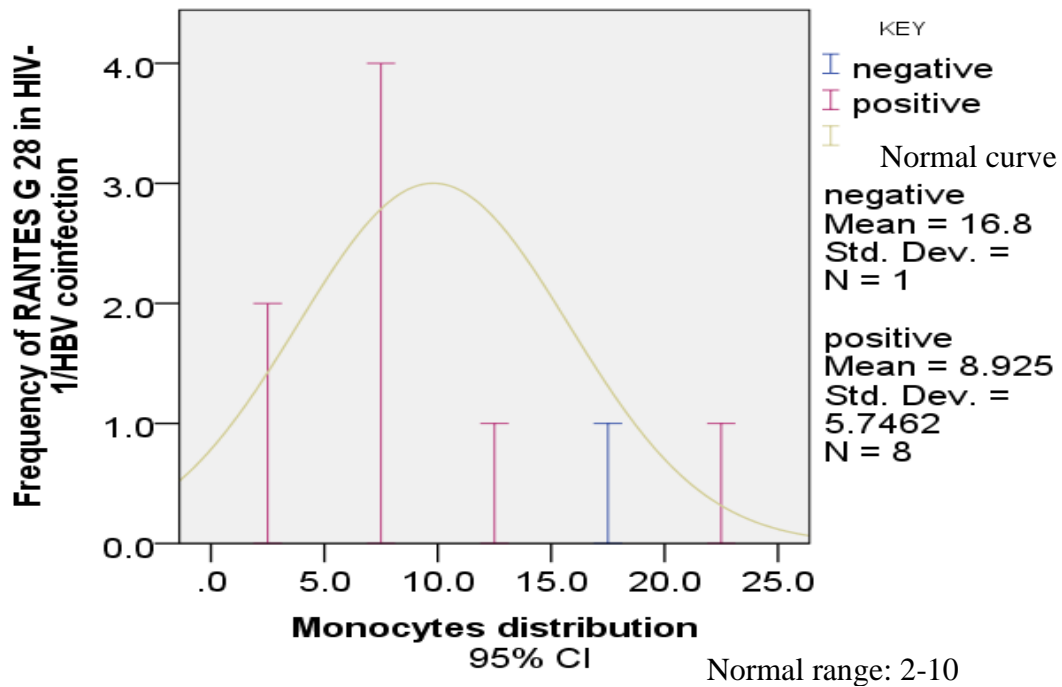

Figure 4.12: The expression of RANTES G 28 at various cells distribution of monocytes (cells/mm³) infected with HIV-1/HBV co infection.

Data shows the mean \pm SD value of the maximum response of monocytes to RANTES G 28 (**Negative**-samples negative for RANTES G 28.**Positive**-samples positive for RANTES G 28).

4.6.4 RANTES G 28 expression in presence of absolute lymphocytes infected with HIV-1/HBV co infection.

The level of absolute lymphocytes (cells/mm³) at various cell distributions and with the expression of RANTES G 28 showed a mean \pm SD (55.8 \pm 17) value that was above normal range. No skewness was demonstrated (Figure 4.13).

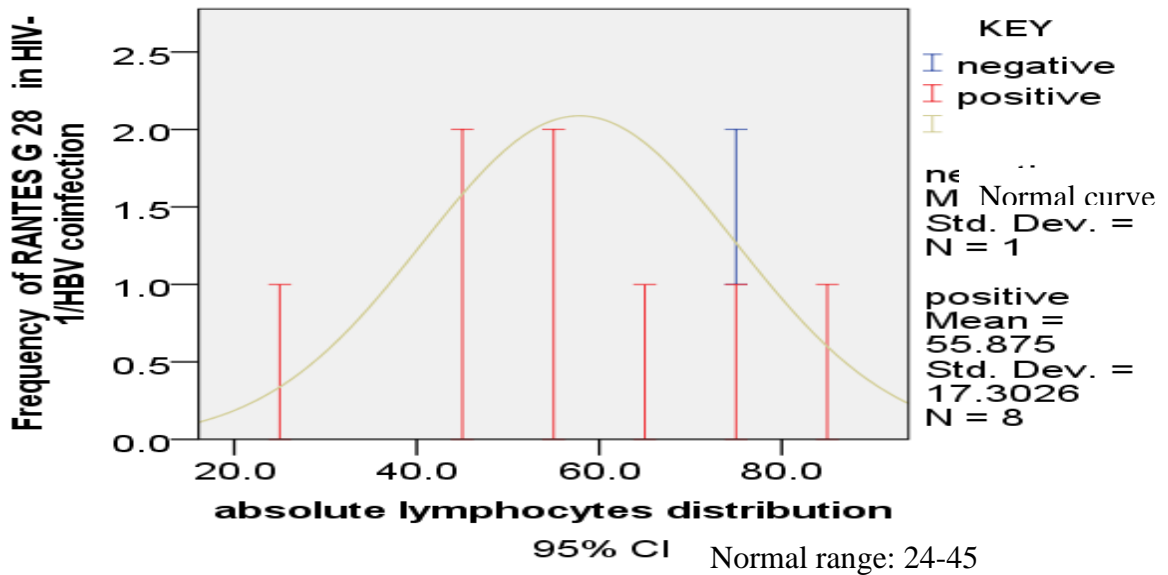

Figure 4.13: Expression of RANTES G 28 at various cell distributions (cells/mm³) of absolute lymphocytes infected with HIV-1/HBV co infection.

Data shows the mean \pm SD value of the maximum response of absolute lymphocytes to RANTES G 28. (**Negative**-samples negative for RANTES G 28. **Positive**-samples positive for RANTES G 28).

4.6.5 RANTES G 28 expression in presence of eosinophils infected with HIV-1/HBV co infection.

At various cell distributions of eosinophils (cells/mm³) with the expression of RANTES G 28 a mean \pm SD (2.9 \pm 3.9) value that was within normal range was demonstrated. A positive skewness was indicated (Figure 4.14).

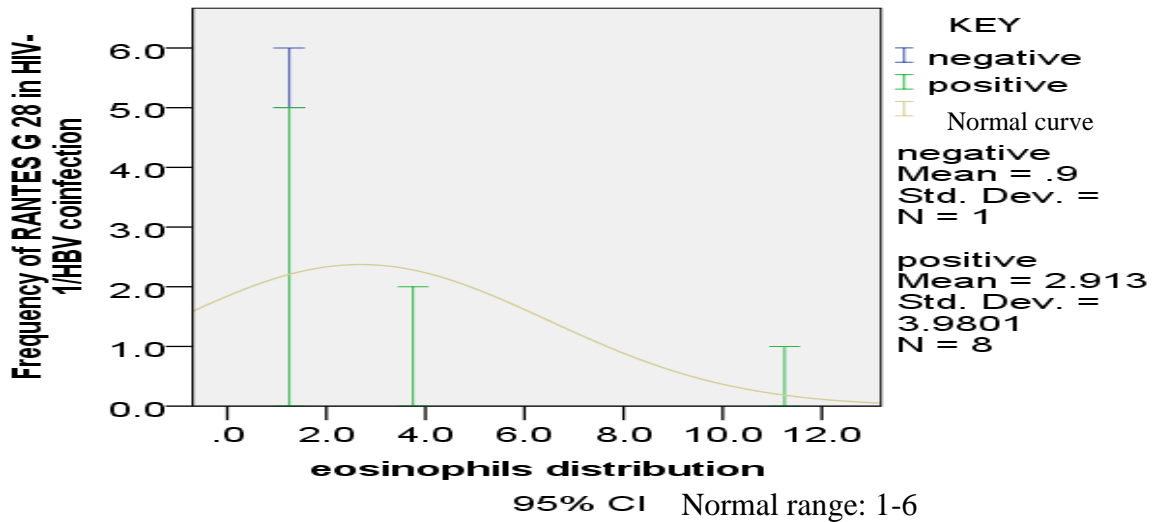

Figure 4.14: The RANTES G 28 is expressed at various cell distributions (cells/mm³) of eosinophils infected with HIV-1/HBV co infection.

Data represent a mean \pm SD value of the maximum response of eosinophils to RANTES G 28. (**Negative**-samples negative for RANTES G 28.**Positive**-samples positive for RANTES G 28).

4.6.6 RANTES G 28 expression in presence of CD4 infected with HIV-1/HBV co infection.

The levels of CD4 (cells/mm³) at various cells distribution and with the expression of RANTES G 28 illustrated a mean \pm SD (275 \pm 155.8) value that was below normal range. No skewness was indicated (Figure 4.15)

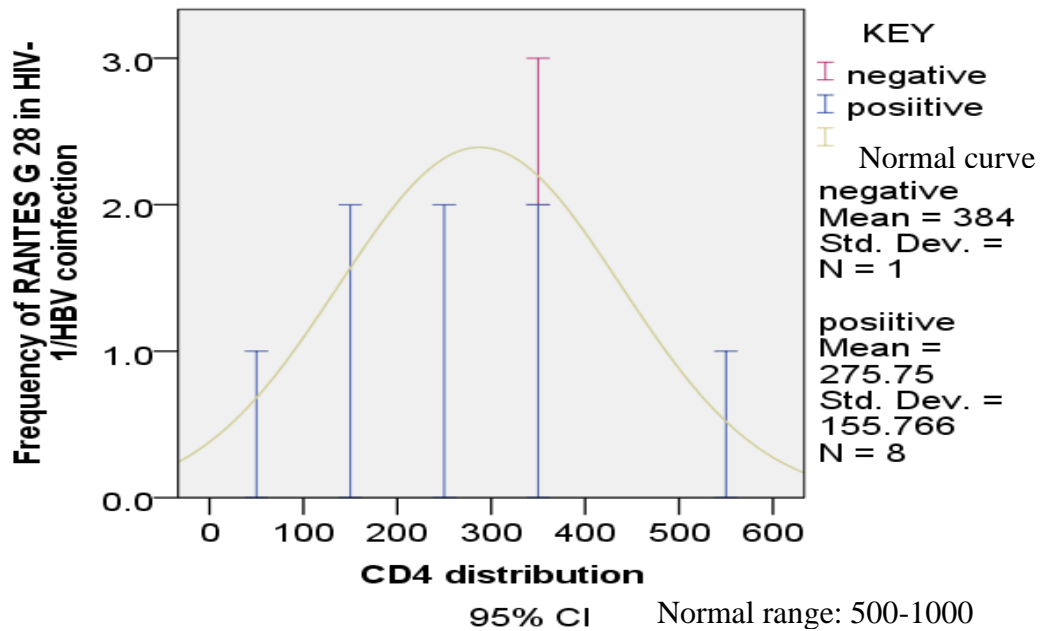

Figure 4.15: Expression of RANTES G 28 at various cell distributions (cells/mm³) of CD4 infected with HIV-1/HBV co infection.

Data represents the mean \pm SD value of the maximum response of CD4 to RANTES G 28. (**Negative**-samples negative for RANTES G 28.**Positive**-samples positive for RANTES G 28).

4.6.7 RANTES G 28 expressions in presence of CD3 infected with HIV-1/HBV co infection.

The expression of RANTES G 28 at various cell distribution of CD3 (cells/mm³) showed a mean \pm SD (1446 \pm 469) value that was within normal range. No skewness was demonstrated as shown in figure 4.16.

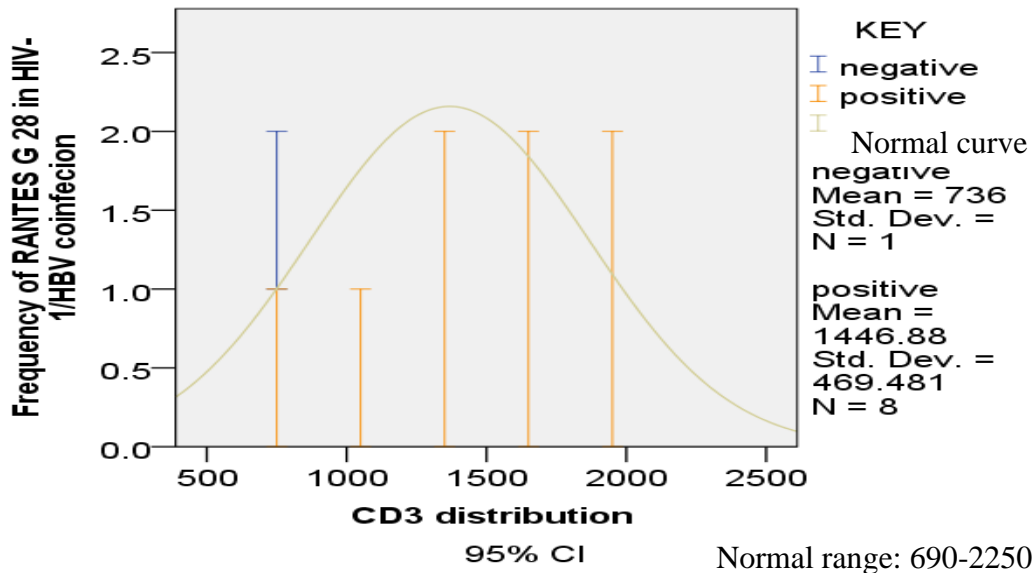

Figure 4.16: The expression of RANTES G 28 at various CD3 distributions (cells/mm³) infected with HIV-1/HBV co infection.

Data present the mean \pm SD value of the maximum response of CD3 to RANTES G 28. (**Negative**-samples negative for RANTES G 28. **Positive**-samples positive for RANTES G 28).

4.6.8 RANTES G 28 expression in presence of neutrophils infected with HIV-1/HBV co infection.

The distribution of neutrophils (cells/mm³) at various cell distributions and with the expression of RANTES G 28 showed a mean \pm SD (31 \pm 19). No skewness was observed as shown in figure 4.17.

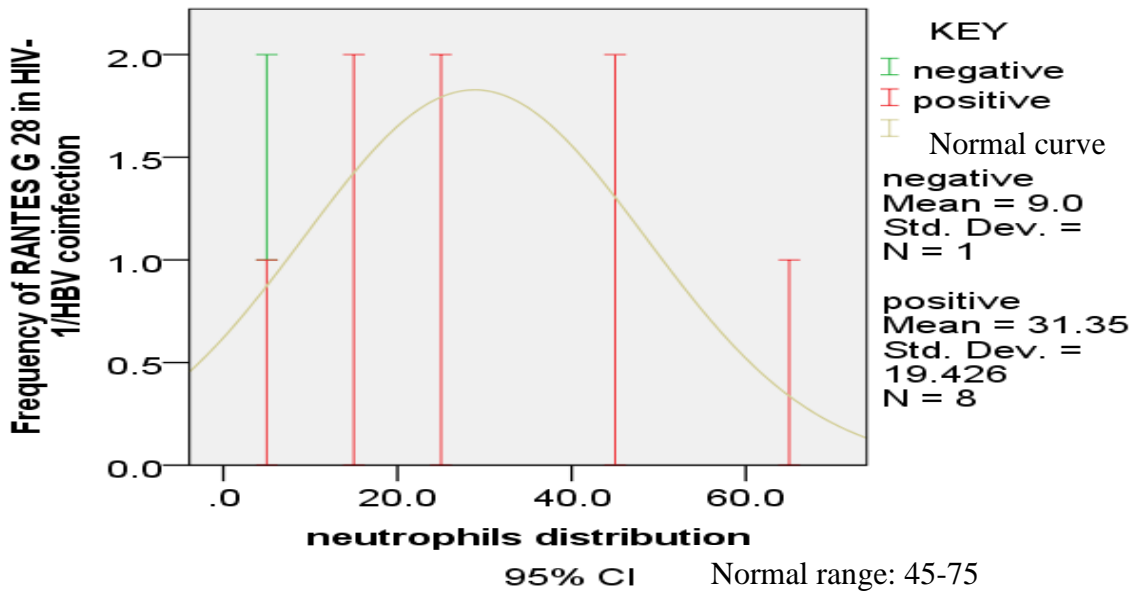

Figure 4.17: The expression of RANTES G 28 at various cell distributions (cells/mm³) of neutrophils infected with HIV-1/HBV co infection.

Data represents the mean \pm SD value of the maximum response of neutrophils to RANTES G 28. (**Negative**-samples negative for RANTES G 28. **Positive**- samples positive for RANTES G 28).

4.7 Expression of RANTES G 28 on leukocytes in presence of HIV-1/HCV co infection

4.7.1 RANTES G 28 expression in presence of CD4 infected with HIV-1/HCV co infection.

The expression of RANTES G 28 at various cell distribution of CD4 (cells/mm³) showed a mean \pm SD (411 \pm 231) value that was below normal range. Moderate skewness was indicated (Figure4.18).

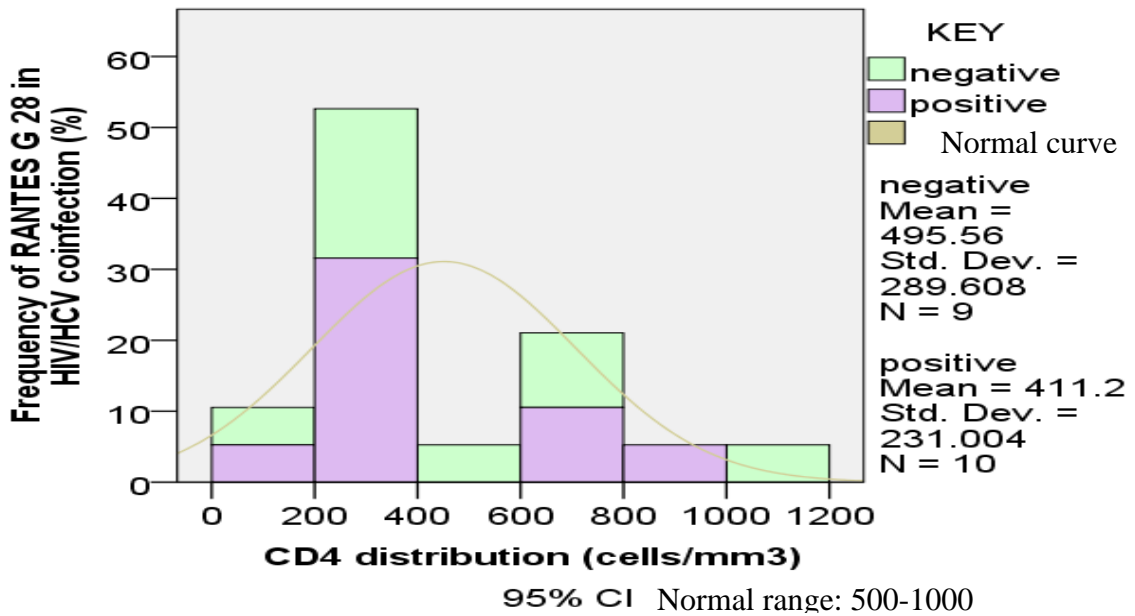

Figure 4.18: The expression of RANTES G 28 at various cell distributions (cells/mm³) of CD4 infected with HIV-1/HCV co infection.

Data represents the mean \pm SD value of the maximum response of CD4 distributions (cells/mm³) to RANTES G 28. (**Negative**-samples negative for RANTES G 28. **Positive**-samples positive for RANTES G 28).

4.7.2 RANTES G 28 expression in presence of absolute lymphocytes infected with HIV-1/HCV co infection.

At various cells distribution of absolute lymphocytes (cells/mm³) and with the expression of RANTES G 28, a mean \pm SD (62 \pm 10.9) value was demonstrated and it was above the reference range. No skewness was indicated (figure 4.19).

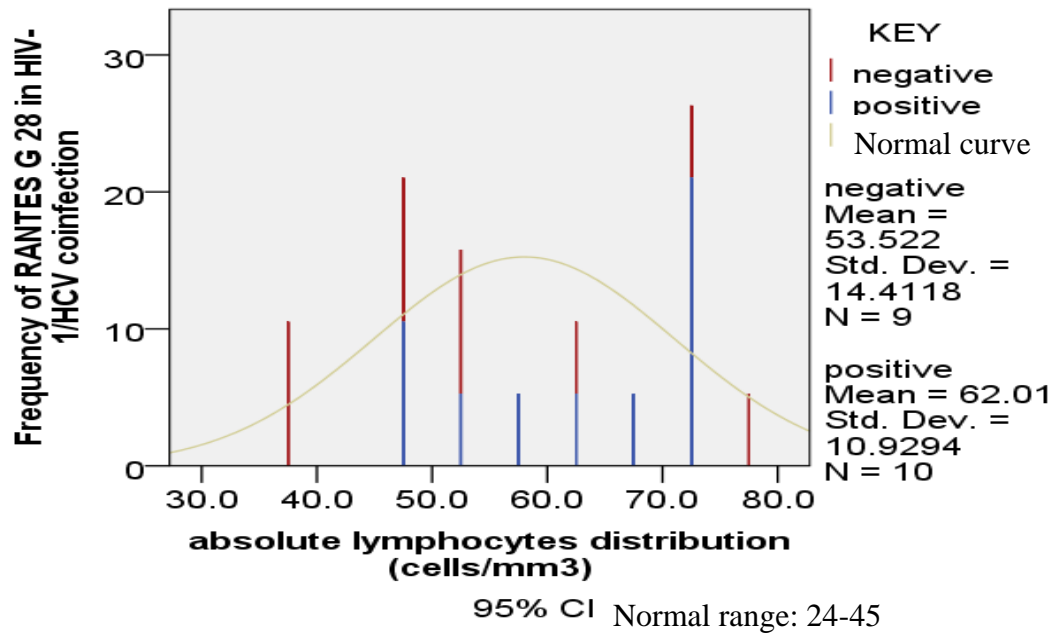

Figure 4.19: Expression of RANTES G 28 at various cell distributions (cells/mm³) of absolute lymphocytes infected with HIV-1/HCV co infection.

Data represents the mean \pm SD value of the maximum response of absolute lymphocytes to RANTES G 28. (**Negative**-samples negative for RANTES G 28. **Positive**-samples positive for RANTES G 28).

4.7.3 RANTES G 28 expression in presence of neutrophils infected with HIV 1/HCV co infection.

The level of neutrophils at various cell distributions (cells/mm³) with the expression of RANTES G 28 demonstrated a mean \pm SD (25 \pm 11.6) value below normal range. No skewness was indicated as shown in figure 4.20.

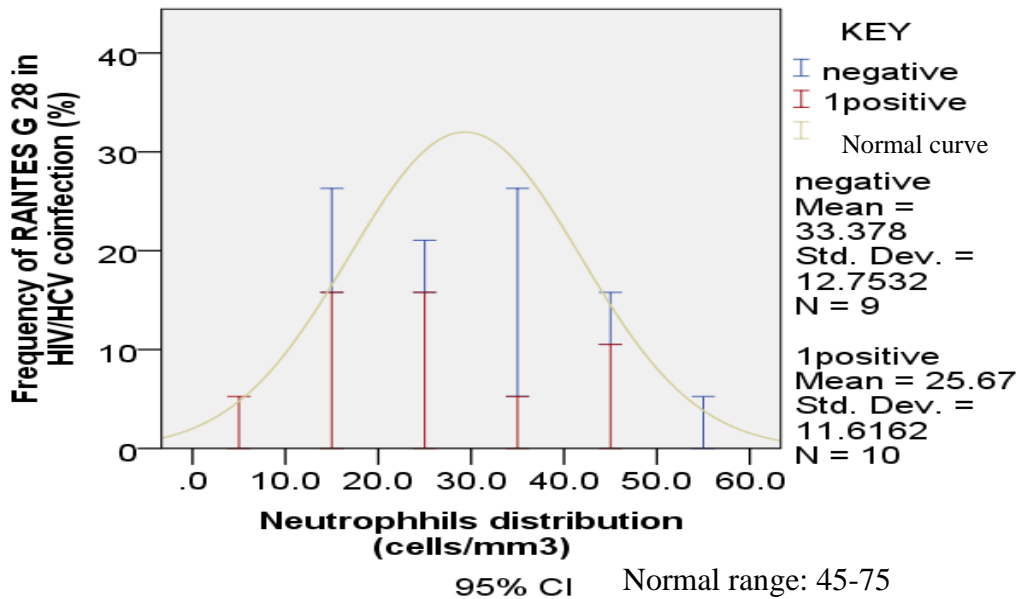

Figure 4.20: Expression of RANTES G 28 at various cell distributions (cells/mm³) of neutrophils infected with HIV-1/HCV co infection.

Data represents the mean \pm SD value of the maximum response of neutrophils to RANTES G 28. (**Negative**-samples negative for RANTES G 28. **Positive**-samples positive for RANTES G 28).

4.7.4 RANTES G 28 expression in presence of monocytes infected with HIV-1/HCV co infection.

The expression of RANTES G 28 at various cells distribution of monocytes (cells/mm³) demonstrated a mean \pm SD (9.8 \pm 6) value that was within normal range. Moderate positive skewness was indicated as shown in figure 4.21.

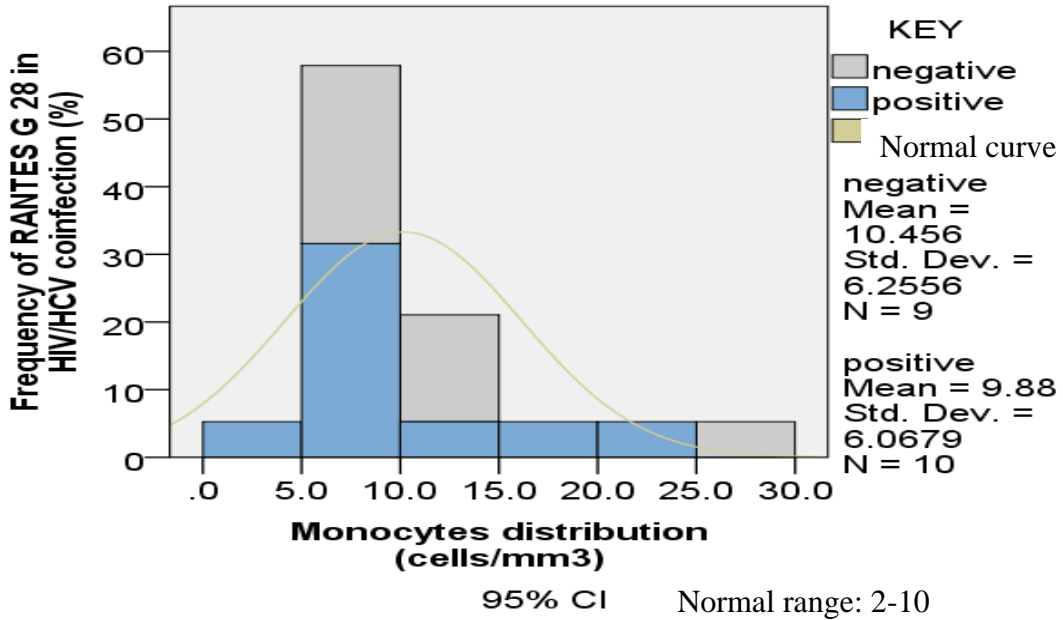

Figure 4.21: Expression of RANTES G 28 at various cell distributions (cells/mm³) of monocytes infected with HIV-1/HCV co infection.

Data represents the mean \pm SD value of the maximum response of monocytes to RANTES G 28. (**Negative**-samples negative for RANTES G 28. **Positive**-samples positive for RANTES G 28).

4.7.5 RANTES G 28 expression in presence of eosinophils infected with HIV-1/HCV co infection

RANTES G 28 expression at different levels of eosinophils distribution (cells/mm³) showed a mean \pm SD (1 ± 8417) value that was within normal range. Moderate positive skewness demonstrated as shown in figure 4.22.

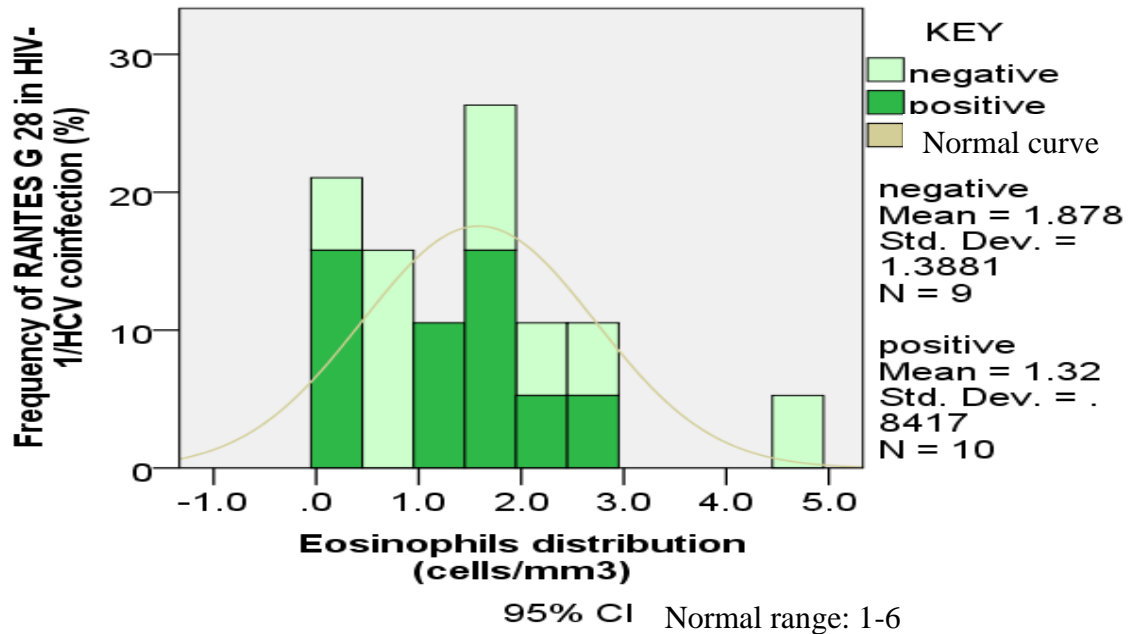

Figure 4.22: Expression of RANTES G 28 at various cell distributions (cells/mm³) of eosinophils infected with HIV-1/HCV co infection.

Data represents the mean \pm SD value of the maximum response of eosinophils to RANTES G 28. (**Negative**-samples negative for RANTES G 28. **Positive**-samples positive for RANTES G 28).

4.7.6 RANTES G 28 expression in presence of basophils infected with HIV-1/HCV co infection.

The distribution of basophils (cells/mm³) and with the expression of RANTES G 28 showed a mean \pm SD (1 \pm 1.5) value that was within normal range. Moderate positive skewness was observed as shown in figure 4.23

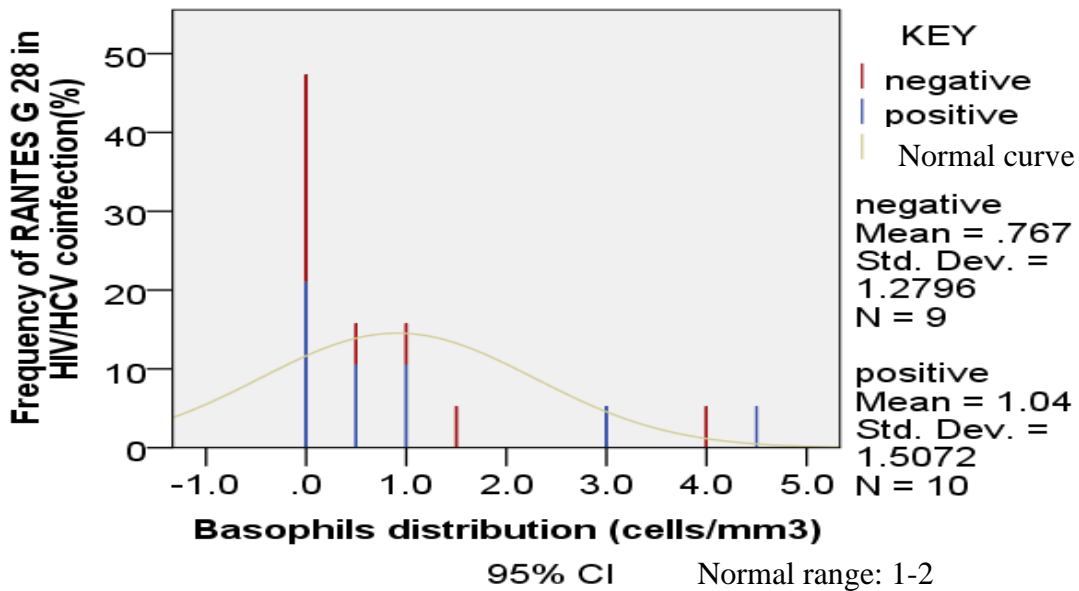

Figure 4.23: Expression of RANTES G 28 at various basophils distribution (cells/mm³) infected with HIV-1/HCV co infection.

Data represents the mean \pm SD value of the maximum response of basophils to RANTES G 28. (**Negative**-samples negative for RANTES G 28. **Positive**-samples positive for RANTES G 28).

4.7.7 RANTES G 28 expression in presence of platelets infected with HIV-1/HCV co infection.

The level of platelets distribution (cells/ μ L) and with the expression of RANTES G 28, a mean \pm SD (182 \pm 55.7) count that was within normal range was indicated. Moderate positive skewness was demonstrated (Figure 4.24).

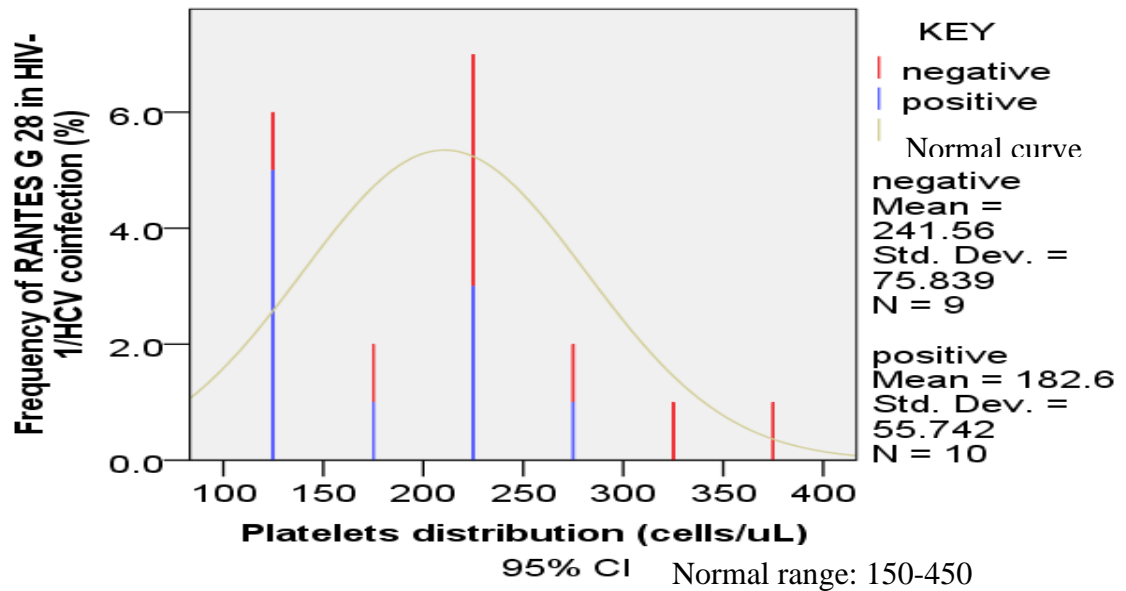

Figure 4.24: Expression of RANTES G 28 at various cell distributions (cells/ μ L) of platelets infected with HIV-1/HCV co infection.

Data demonstrated the mean \pm SD value of the maximum response of platelets to RANTES G 28. (**Negative**-samples negative for RANTES G 28. **Positive**-samples positive for RANTES G 28).

4.7.8 RANTES G 28 expression in presence of CD3 infected with HIV-1/HCV co infection.

The distribution of CD3 (cells/ mm^3) at various cell distribution and with the expression of RANTES G 28 showed a mean \pm SD (1796 \pm 336) value that was within normal range. A moderate negative skewness was indicated (Figure 4.25).

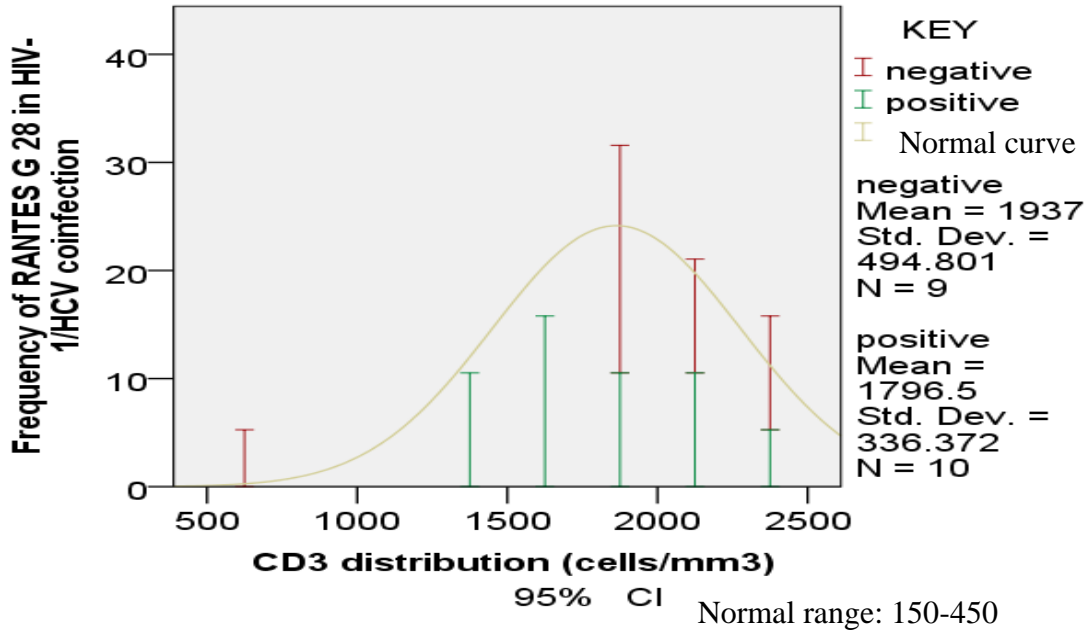

Figure 4.25: Expression of RANTES G 28 at various cell distributions of CD3 (cells/mm3) infected with HIV-1/HCV co infection.

Data shows a mean \pm SD value of the maximum response of CD3 to RANTES G 28. (**Negative-samples** negative for RANTES G 28. **Positive-samples** positive for RANTES G 28).

4.8 Expression of RANTES G 28 in presence of HIV-1/HBV/HCV co infection

The distribution of leukocytes in various cell levels in presence of HIV-1/HBV/HCV co infection showed RANTES G 28 expression as shown in figure 4.26

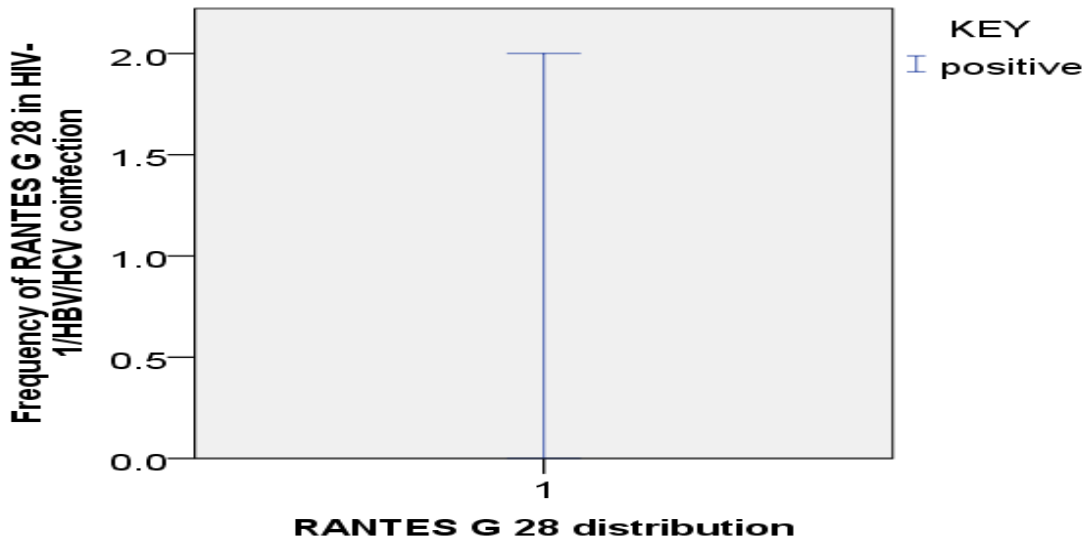

Figure 4.26: Expression of RANTES G 28 at various stated cell distributions infected with HIV-1/HBV/HCV co infection.

Data represents the maximum response of the cells distribution to RANTES G 28.

CHAPTER FIVE

DISCUSSION

5.1 Seroprevalance of HIV-1/ HIV-1/HBV, HIV-1/HCV and HIV-1/HBV/HCV co infection.

The seroprevalence of HBV and HCV among HIV positive blood samples showed that 4% was HIV-1/HBV, 8.8% HIV-HCV and 0.8 % HIV-HBV-HCV co infection. An earlier study by Landrum *et al.*, (2010) reported that approximately 20% of HBV infections occur after HIV diagnosis, suggesting that patients with HIV-1 are frequently co-infected with Hepatitis B virus (HBV) and have high prevalence of hepatitis B surface antigen (HBsAg) or hepatitis B core antibody (HBcAb)-positive HBV serological markers (Zhang *et al.*.,2013).

The results of HIV/HCV co infection seroprevalence was almost comparable with the seroprevalence in Nigeria (5.8%), Malawi (5.0%), Burkina Faso (4.8%) and Senegal (8.0%) (Lesi *et al.*, 2007; Nyirenda *et al.*., 2008 ; Simpire *et al.*., 2006 ; Diop-Ndiaye *et al.*, 2008). Hernandez *et al.*, (2011) indicated that HIV generates a metabolic pathway that leads to liver toxicity, suggesting direct viral effects, immune/cytokine dysregulation, altered levels of matrix metalloproteinase's, fibrosis biomarkers, increased oxidative stress and hepatocyte apoptosis (Mastroianni *et al.*, 2014).

The findings of HIV-1/HBV co infection seroprevalence is comparable to the work of Thio *et al.*, (2002) who showed that HIV infection accelerates HBV-related liver damage, cirrhosis and end-stage liver disease. This shows that the presence of HBV infection complicates the management of HIV infection, impairs CD4 recovery, accelerates immunologic progression and increases the morbidity and mortality of HIV-infected patients Thio *et al.*, 2002).

The HIV-1/HBV/HCV co infection seroprevalence was shown to be more or less comparable to results from Senegal (0.5%), Nigeria (1.5%) and Egypt (0.44%) (Olufemi *et al.*, 2009; Kazem *et al.*, 2004; Diop-Ndiaye *et al.*, 2008).

5.2 The effects of HIV-1 Infection on leukocytes (CD4, CD3, absolute lymphocytes, neutrophils, monocytes, eosinophils, Basophils and platelets)

The findings of this study showed that mean \pm SD level of neutrophils and CD4 was low. The results are inconsistent with those of Christopher *et al.*, (2007), who reported that there is persistent neutropenia in HIV-1 infection. They suggested that this was incapability of neutrophils to release defensins and other antimicrobial peptides that suppress HIV-1 replication (Zhang *et al.*, 2002). The CD4 mean \pm SD levels concurred with Stephen *et al.*, (1998) who showed that the progressive destruction and functional impairment of the CD4⁺T cell, that is associated with HIV infection. This is a prognostic indicator for risk of developing opportunistic infections (Henry *et al.*, 2005).

The absolute lymphocytes mean \pm SD count was high. The results are supported by a report by Moir *et al.*, (2004) that showed lymphocyte populations are depleted during HIV-1 infection due to the establishment of a proapoptotic environment. Stephen *et al.*, (1998) reported that the T-cell numbers decline during HIV-1 infection, that suggested the development of profound immunodeficiency, a marked and persistent cellular immune activation.

The distribution levels of CD3, monocytes, eosinophils, basophils and platelets indicated normal mean \pm SD values. The results are supported by Nicholson *et al.*, (2002) who showed that blood basophil presents a granulocyte type that is most resistant to spontaneous apoptosis in HIV-1 infection, while Sonza *et al.*, (1994) showed that blood monocytes from HIV-1 infected individuals harbor HIV-1 DNA, although at a low

frequency (<0.1%). Meanwhile Freedman *et al.*, (1991) showed that there is an increased eosinophils numbers that are infectable with HIV infection.

The results of this study are comparable to what had previously been studied. Most reports indicated that thrombocytopenia is demonstrated with HIV infection and appears to involve increased platelet destruction and ineffective platelet production (Henry *et al.*, 2005), while marked eosinophilia has been observed in HIV-1-infected patients Cohen *et al.*, (1996), this could be due to eosinophilic folliculitis disorder in HIV-positive patients (Skiest & Keiser, 1997).

A report by Marone *et al.*, (2001) showed that there is a shift from Th1 cytokine production to Th2 cytokine production, due to the HIV-1 infection induces degranulation of basophils.

5.3 Association between HIV-1, HBV and HCV infection

A positive correlation was observed between the HIV-1 infection and HBV or HCV. An earlier report by Simon *et al.*, (2014) showed that the principal routes of HIV and hepatotropic viruses such as HBV and HCV are similar, that makes co infection of these viruses with HIV possible. The result evidently suggests that there is a link between immunological and metabolic perturbations in particular, the increased production of proinflammatory cytokines and perturbation in adipokines (De Castro *et al.*, 2010).

The results showed that the size effect of HCV and HBV/HCV infections in HIV-1 infection was to increase. It has been shown that the HIV and hepatic disease are independently known to cause a varied range of haematological and biochemical changes (Simon *et al.*, 2014). However the effect of HIV-1 infection was to reduce with HBV infection. This could be partly because of the enormous assault of these viruses on haemopoietic cells/system and the role of the liver in haemopoiesis and coagulation (Bibas *et al.*, 2011). The findings of the study showed there was a chance of HCV, HBV

infections and HBV/HCV co infection occurring during HIV-1 infection. Lodenyo *et al.*, (2000) indicated that the levels of the liver enzymes with HIV-HBV-HCV co-infected individuals are raised.

5.4 The effect of HIV-1/HBV co infection on CD4, CD3, absolute lymphocytes, Neutrophils, Monocytes, Eosinophils, Basophils and platelets.

The mean \pm SD levels of neutrophils, basophils and CD4 were low during HIV-1/HBV co infection. This results concurred with Di Martino *et al.*, (2002) who demonstrated that CD4 count is low in HIV infection patients with HBV co infection, suggesting HIV-1 infection accelerates the progression of HBV-related liver disease causing lower alanine aminotransferase (ALT) levels and relates to lower CD4 T cell counts (Di Martino *et al.*, 2002). The neutrophil levels supported a report by Revill *et al.*, (2007) that demonstrated infection by HIV-1/HBV induces apoptosis and functional impairment of neutrophils. This suggested the compromising effects of the neutrophils capacity for phagocytosis, oxidative burst, and bacterial killing, thus unable to control opportunistic pathogens.

The eosinophils and basophils mean \pm SD count was also low. The results are consistent with Weller *et al.*, (1995) who showed that *in vitro* viral-infected eosinophils do not survive and they die by apoptosis or necrosis. Weller *et al.*, (1995) suggested that activated eosinophils can generate a number of toxic substances (eosinophil peroxydase, hydrogen peroxide and holide ions) which have lytic effect.

The levels of absolute lymphocytes mean \pm SD count was high. The results are consistent with that of Fang *et al.*, (1993) who indicated that the quality of the HBV specific T-cell response is impaired in the setting of HIV-1-HBV co infection. This suggests that HIV modulation of the HBV-specific immune response can alter the hepatic cytokine environment and subsequently affect liver disease (Thio *et al.*, 2002).

A positive correlation was found between HIV-1/HBV co infection and CD4, CD3, absolute lymphocytes, neutrophils, monocytes, eosinophils, basophils and platelets. The findings of this study showed that the effect of HIV-1/HBV co infection, with an additional effect of CD3, CD4, absolute lymphocytes, basophils and platelets was to reduce. Several studies had suggested that patients infected with HBV genotypes C and D had lower rates of seroconversion, likely correlated with delayed onset of spontaneous HBV envelope antigen (HBeAg) seroconversion and HBsAg seroclearance (Yuen *et al.*, 2004). The additional effect of monocytes and eosinophils showed an increase in HIV-1/HBV co infection. The result suggests that HIV-1/HBV-co infected patients may have faster progression of hepatic fibrosis, a higher risk of cirrhosis, end-stage liver disease, and HCC (Yuen *et al.*, 2004). However neutrophils showed no effect on HIV-1/HBV co infection.

There was a positive change of CD3, CD4, monocytes, eosinophils, basophils and platelets occurring during HIV-1/HBV co infection; however there was no indication of neutrophils and absolute lymphocytes occurring during the co infection. A previous report by Graham *et al.*, (2001) showed that the HIV virus cannot enter hepatocytes directly but it can up regulate pro-fibrotic pathways like transform growth factor B-1 which further activates hepatic stellate cells. HIV infection may be therefore ascribable to a profound dysregulation of the peripheral and intrahepatic cytokine networks, which plays an important role in the accelerated evolution of liver fibrosis (Mehal *et al.*, 2007).

5.5 The effect of HIV-1/HCV co infection on leukocytes (CD4, CD3, absolute lymphocytes, neutrophils, monocytes, eosinophils, basophils and platelets)

The absolute lymphocytes mea \pm SD level was high. A study by Flynn *et al.*,(2012) indicated that HIV/HCV co infection is associated with a reduction in the number of HCV-specific T cells and a reduction in the anti-fibrotic activity of NK cells (Glässner *et*

al., 2013). The results suggest that an increased HIV and HCV replication reflect the immune suppressed state (Wondimeneh *et al.*, 2013).

CD4, basophils and neutrophils mean \pm SD levels were low. The results support a report by Glässner *et al.*, (2013) who demonstrated that HIV/HCV induced loss of CD4+ T cells and dysregulated CD4+ T cell function. However Sulkowski *et al.*, (2003) explained that co infection of HIV and hepatitis C virus lead to increased HCV RNA levels, and this promotes viral persistence in primary infection (Yang *et al.*, 2008).

The CD3, eosinophils, monocytes and platelets mean \pm SD levels were normal. Different from these results, low platelet counts have been shown to be strongly correlated with liver fibrosis (Testa *et al.*, 2005).

The results demonstrated a positive correlation between HIV-1/HCV co infection and CD4, CD3, absolute lymphocytes, neutrophils, monocytes, eosinophils, basophils and platelets. A report by WHO, (2009); Adewole, (2009) explained that co infection with HIV-1/HCV is associated with the likelihood of disease progression and thus reduces immunity. This shows that mechanisms for the accelerated fibrosis rate appear to be multi-factorial and include a weaker adaptive immune response (Blackard *et al.*, 2006).

The results showed that the effect of HIV-1/HCV co infection was to reduce with the effect of CD4, absolute lymphocytes, neutrophils, basophils and eosinophils. McKiernan *et al.*, (2004) explained that human leukocyte antigen B27 (HLA-B27) is associated with slow disease progression in HIV infection and a high rate of spontaneous viral clearance in hepatitis C virus (HCV) infection. However the effect of HIV-1/HCV co infection was to increase with the presences platelets, monocytes and CD3. Therefore leads to the lethal disease fibrosing cholestatic hepatitis, related to the direct cytotoxicity of HCV. High levels of viremia lead to an accumulation of viral proteins in the endoplasmic reticulum and to hepatocyte death (Tolan DJ *et al.*, 2001).

There was a chance of CD3, CD4, absolute lymphocytes, neutrophils, monocytes, eosinophils, basophils and platelets occurring in presence of HIV-1/HCV co infection.

5.6 The effect of HIV-1/HBV/HCV co infection on CD4, CD3, absolute lymphocytes, neutrophils, monocytes, eosinophils, basophils and platelets.

A positive correlation was found between HIV-1/HBV/HCV co infection and CD3, CD4, absolute lymphocytes, neutrophils, monocytes, eosinophils, basophils and platelets. The findings of the study demonstrated that the mean \pm SD levels of CD4, neutrophils and basophils were low but high with absolute lymphocytes and monocytes. The CD3, eosinophils and platelets mean \pm SD levels were normal. The results showed that the effect of HIV-1/HCV/HBV co infection was to reduce with the effect of CD4, absolute lymphocytes, monocytes, eosinophils, basophils and platelets but increased with the effect of CD3 and neutrophils. There was a chance of CD3, CD4, absolute lymphocytes, neutrophils, monocytes, eosinophils, basophils and platelets occurring in presence of HIV-1/HCV/HBV co infection.

5.7 Expression of RANTES G 28 in presence of HIV-1, HIV-1/HBV, HIV-1/HCV and HIV-1/HBV/HCV co infection

RANTES G 28 was shown to be highly expressed in HIV-1 infected blood samples. The results are consistent to that of Gonzalez *et al.*, (2002) who showed that RANTES SNPs 28 C/G haplotypes are related to HIV infection progression, also with this, Zhenghua *et al.*, (2013) who found out that marginal association between RANTES -28C/G with the susceptibility to HIV-1 infection.

RANTES G 28 was also expressed in HIV-1/HBV, HIV-1/HCV and HIV-1/HBV/HCV co infection blood samples. Study by Promrat *et al.*, 2003 outlined the role of polymorphisms of the genes for RANTES and their ligands in HCV susceptibility and disease prognosis.

The findings demonstrated that there was a positive correlation between RANTES G 28 and HIV-1 infection, HIV-1/HBV and HIV-1/HBV/HCV co infections. The results are consistent with that of Duan *et al.*, (2005) who showed a significant correlation was found between plasma RANTES levels and HBV infection. In addition, the results are also consistent with studies that had examined the association of 28C>G SNPs with viral and non-viral diseases including HIV, upper urinary tract infection, asthma, lymphoma, type 1 diabetes, and hepatitis C virus (Hizawa *et al.*, 2002; Zhang *et al.*, 2010).

The results showed that the effect of RANTES G 28 was to increase with the effect of HIV-1 infection, HIV-1/HBV and HIV-1/HBV/HCV co infections but reduced with HIV-1/HCV co infection. This is in agreement with Yang *et al.*, (2008) who showed that the prevalence of RANTES G 28 alleles is low in HIV/HCV co infected patients. Similarly Alam *et al.*, (1993) explained that the increased level of RANTES G 28 is associated with both atopic asthma and nonatopic asthma in bronchoalveolar lavage fluid. This suggests that in human cell lines, the -28G increase promoter activity, and polymorphism can increase RANTES expression in the human body (Liu *et al.*, 1999).

There was a chance of RANTES G 28 occurring in the presence HIV-1/HBV, HIV-1/HCV, HIV-1/HBV and HIV-1/HBV/HCV co infection. A previous report by Heydtmann *et al.*, (2001) demonstrated that RANTES interaction is important during hepatitis C virus infection, where T cells are recruited to the liver parenchyma to mediate clearance of HCV infected hepatocytes. In agreement with this, Hellier *et al.*, (2003) found out an association between RANTES and reduced portal inflammation and milder fibrosis.

5.8 The effect of RANTES G 28 during HIV-1infection, HIV/HBV, HIV/HCV co infection on CD4, CD3, absolute lymphocytes, neutrophils, monocytes, eosinophils, basophils and platelets.

The results showed a positive correlation between RANTES G 28 and CD3, CD4, absolute lymphocytes, neutrophils, monocytes, eosinophils, basophils and platelets. Concurrent with the results, RANTES was found to be highly expressed in activated T lymphocytes, macrophages, fibroblasts, platelets, mesangial cells, epithelial cells, megakaryocytes and some tumours (Yoshie *et al.*, 2001).

The expression of RANTES G 28 showed a normal mean \pm SD level with CD3, monocytes, eosinophils, basophils and platelets, while CD4 and neutrophils mean \pm SD levels were lower than the reference range. Conversely it was reported that over expression of RANTES causes increased neutrophils and eosinophils infiltration into the airways, which are considered a prominent feature of airway inflammation (Pan *et al.*, 2000). However the absolute lymphocytes mean \pm SD level was high.

The results showed that the effect of RANTES G 28 was to increase with in presence of CD3, CD4, absolute lymphocytes, monocytes and platelets. A previous report by Issekutz, (1993) showed that cytokines induce the production of RANTES which leads to recruitment of additional macrophages and memory T helper cells. The findings further showed that an additional effect of neutrophils, eosinophils and basophils was to reduce the size effect of RANTES G 28. A study by Hizawa *et al.*, (2002) found out that mononuclear cells with RANTES G 28G allele produce greater levels of RANTES protein, and it has also been shown that RANTES induces recruitment of eosinophils and their up regulation (Alam *et al*, 1993). The results further showed that there was a positive chance of RANTES G 28 occurring in presence of absolute lymphocytes, neutrophils, basophils and platelets.

CHAPTER SIX

CONCLUSION, LIMITATIONS AND RECOMMENDATION

6.1 Conclusion

1. HIV-1 infection caused low mean \pm SD levels of CD4 and neutrophils were reduced but high levels with absolute lymphocytes.
2. The HIV-1/HBV co infection demonstrated a positive correlation with all stated leukocytes a part from neutrophils. The effect of HIV-1/HBV co infection was reduced in presences of CD3, CD4, absolute lymphocytes, basophils and platelets.
3. The HIV-1/HCV co infection demonstrated a positive correlation with all the stated leukocytes. The effect of HIV-1/HCV co infection was to reduce with an additional effect of CD4, absolute lymphocytes, neutrophils, basophils and eosinophils..
4. The HIV-1/HBV/HCV co infection demonstrated a positive correlation with all stated leukocytes. The size effect of HIV-1/HBV/HCV co infection was to reduce with additional effect of CD3, CD4, absolute lymphocytes, .monocytes, eosinophils and basophils.
5. RANTES G 28 is highly expressed in presence of HIV-1 infection, HIV-1/HBV and HIV-1/HCV co infections. RANTES G 28 expresses a positive correlation with all the infections and leukocytes. The effect of RANTES G 28 was to

increase in presence of HIV-1 infection, HIV-1/HBV and HIV-1/HBV/HCV co infections. RANTES G 28 effect was also to increase with an additional effect of CD3, CD4, absolute lymphocytes, monocytes and platelets.

6.2 Limitation

Large number of blood samples was required to increase the size of co infected blood samples; however this was limited due to lack of resources. Samples coagulated with any other anticoagulant apart from E.D.T.A were rejected as they mostly failed to produce reproducible results

6.3 Recommendation

1. More research is required both by the institutions of higher learning and research institution to understand the role played by HIV infection, HIV/HCV and HIV/HBV co infection on immune cells and understanding the role of RANTES G 28 during the infections and in presence of leukocytes.
2. The health facilities and research institutions should take the initiative of screening of HBV and HCV co infection on HIV-1 individuals.
3. Quantification of human body molecules should be studied to gain knowledge of their importance with reference to the presence of infections.

REFERENCES

- Adewole, O. O., Anteyi, E., Ajuwon, Z., Wada, I., Elegba, F., Ahmed, P., ...& Erhabor, G. E. (2009). Hepatitis B and C virus co-infection in Nigerian patients with HIV infection. *The Journal of Infection in Developing Countries*, 3(05), 369-375.
- Alam, R., Stafford, S., Forsythe, P., Harrison, R., Faubion, D., Lett-Brown, M. A., & Grant, J. A. (1993). RANTES is a chemotactic and activating factor for human eosinophils. *The Journal of Immunology*, 150(8), 3442-3448.
- American Public Health Association, (2008). Acquired immunodeficiency syndrome. In: Heymann, D.L., editor. *Control of Communicable Diseases Manual*. 19th ed. p. 1-9.
- Appay, V., Brown, A., Cribbes, S., Randle, E., & Czaplowski, L. G. (1999). Aggregation of RANTES Is Responsible for Its Inflammatory Properties Characterization of Nonaggregating, Noninflammatory Rantes Mutants. *Journal of Biological Chemistry*, 274(39), 27505-27512.
- Appay, V., Dunbar, P. R., Cerundolo, V., McMichael, A., Czaplowski, L., & Rowland-Jones, S. (2000). RANTES activates antigen-specific cytotoxic T lymphocytes in a mitogen-like manner through cell surface aggregation. *International immunology*, 12(8), 1173-1182.
- Asl, S. K. H., Avijgan, M., & Mohamadnejad, M. (2004). High prevalence of HBV, HCV, and HIV infections in Gypsy population residing in Shahr-E-Kord. *Popul*, 3, 4.
- Backmund, M., Meyer, K., Von Zielonka, M., & Eichenlaub, D. (2001). Treatment of hepatitis C infection in injection drug users. *Hepatology*, 34(1), 188-193.

- Barcellini, W., Rizzardi, G. P., Borgh, M. O., Fain, C., Lazzarin, A., & Meroni, P. L. (1994). TH1 and TH2 cytokine production by peripheral blood mononuclear cells from HIV-infected patients. *Aids*, 8(6), 757-762.
- Benhamou, Y., Bochet, M., Di Martino, V., Charlotte, F., Azria, F., Coutellier, A., ...& Poynard, T. (1999). Liver fibrosis progression in human immunodeficiency virus and hepatitis C virus coinfecting patients. *Hepatology*, 30(4), 1054-1058.
- Bibas, M., Biava, G., & Antinori, A. (2011). HIV-associated venous thromboembolism. *Mediterranean journal of hematology and infectious diseases*, 3(1), 2011-3006.
- Bica, I., McGovern, B., Dhar, R., Stone, D., McGowan, K., Scheib, R., & Snyderman, D. R. (2001). Increasing mortality due to end-stage liver disease in patients with human immunodeficiency virus infection. *Clinical infectious diseases*, 32(3), 492-497.
- Blackard, J. T., Komurian-Pradel, F., Perret, M., Sodoier, M., Smeaton, L., Clair, J., ...& Chung, R. T. (2006). Intrahepatic cytokine expression is downregulated during HCV/HIV co-infection. *Journal of medical virology*, 78(2), 202-207.
- Blair, P., & Flaumenhaft, R. (2009). Platelet α -granules: basic biology and clinical correlates. *Blood reviews*, 23(4), 177-189.
- Boasso, A., & Shearer, G. M. (2008). Chronic innate immune activation as a cause of HIV-1 immunopathogenesis. *Clinical immunology*, 126(3), 235-242.
- Brenchley, J. M., Price, D. A., Schacker, T. W., Asher, T. E., Silvestri, G., Rao, S., ...& Blazar, B. R. (2006). Microbial translocation is a cause of systemic immune activation in chronic HIV infection. *Nature medicine*, 12(12), 1365-1371.

- Brenchley, J. M., Schacker, T. W., Ruff, L. E., Price, D. A., Taylor, J. H., Beilman, G. J., ... & Douek, D. C. (2004). CD4+ T cell depletion during all stages of HIV disease occurs predominantly in the gastrointestinal tract. *The Journal of experimental medicine*, 200(6), 749-759.
- Champagne, P., Ogg, G. S., King, A. S., Knabenhans, C., Ellefsen, K., Nobile, M., ...& Förster, R. (2001). Skewed maturation of memory HIV-specific CD8 T lymphocytes. *Nature*, 410(6824), 106-111.
- Christopher, M. J., & Link, D. C. (2007). Regulation of neutrophil homeostasis. *Current opinion in hematology*, 14(1), 3-8.
- Cleghorn, F. R., Reitz, M. S., Popovic, M., & Gallo, R. (2005). Human immunodeficiency viruses. *Mandell G. BJDR, ed. Principles and practice of infectious diseases. Elsevier.*
- Cochran, W. G. 1963. Sampling Techniques.(2nd ed.), New York: John Wiley and Sons, Inc.
- Cohen, A. J., & Steigbigel, R. T. (1996). Eosinophilia in patients infected with human immunodeficiency virus. *Journal of Infectious Diseases*, 174(3), 615-618.
- Damond, F., Worobey, M., Campa, P., Farfara, I., Colin, G., Matheron, S., ...& Simon, F. (2004). Identification of a highly divergent HIV type 2 and proposal for a change in HIV type 2 classification. *AIDS research and human retroviruses*, 20(6), 666-672.
- De Castro, I. F., Berenguer, J., Micheloud, D., Guzmán-Fulgencio, M., Cosín, J., Álvarez, E., ...& Resino, S. (2010). Serum levels of adipokines in HIV/HCV co-

infected patients and their association with insulin resistance and liver disease severity. *Journal of Infection*, 61(6), 499-501.

Demarest, J. F., & Pantaleo, G. (1994). Major expansion of CD8+ T cells with a predominant VB usage during the primary immune response to. *Nature: International weekly journal of science*, 370(6489), 463-467.

Di Martino, V., Thevenot, T., Colin, J. F., Boyer, N., Martinot, M., Degos, F., ...& Valla, D. (2002). Influence of HIV infection on the response to interferon therapy and the long-term outcome of chronic hepatitis B. *Gastroenterology*, 123(6), 1812-1822.

Diop-Ndiaye, H., Touré-Kane, C., Etard, J. F., Lo, G., Diaw, P. A., Ngom-Gueye, N. F., ...& Delaporte, E. (2008). Hepatitis B, C seroprevalence and delta viruses in HIV-1 Senegalese patients at HAART initiation (retrospective study). *Journal of medical virology*, 80(8), 1332-1336.

Duan, Z. P., Zhao, X. Y., Huang, D. Z., He, L. X., Chen, Y. U., Zhao, C. H., & Zheng, B. J. (2005). RANTES gene single nucleotide polymorphisms and expression in patients with chronic hepatitis B virus infection. *Chinese medical journal*, 118(11), 909-914.

Elder, G. A., & Sever, J. L. (1988). Neurologic disorders associated with AIDS retroviral infection. *Review of Infectious Diseases*, 10(2), 286-302.

Fang, J. S., Wright, T., & Lau, J. N. (1993). Fibrosing cholestatic hepatitis in patient with HIV and hepatitis B. *The Lancet*, 342(8880), 1175.

Flynn, J. K., Dore, G. J., Matthews, G., Hellard, M., Yeung, B., Rawlinson, W. D., ...& ATACH Study Group. (2012). Impaired hepatitis C virus (HCV)-specific

- interferon- γ responses in individuals with HIV who acquire HCV infection: correlation with CD4+ T-cell counts. *Journal of Infectious Diseases*, 206(10), 1568-1576.
- Foley, P., Kazazi, F., Biti, R., Sorrell, T. C., & Cunningham, A. L. (1992). HIV infection of monocytes inhibits the T-lymphocyte proliferative response to recall antigens, via production of eicosanoids. *Immunology*, 75(3), 391.
- Ford, E. S., Puronen, C. E., & Sereti, I. (2009). Immunopathogenesis of asymptomatic chronic HIV Infection: the calm before the storm. *Current opinion in HIV and AIDS*, 4(3), 206.
- Freedman, A. R., Gibson, F. M., Fleming, S. C., Spry, C. J., & Griffin, G. E. (1991). Human immunodeficiency virus infection of eosinophils in human bone marrow cultures. *The Journal of experimental medicine*, 174(6), 1661-1664.
- Gabrilovich, D. I., Vassilev, V., Nosikov, V. V., Serebrovskaya, L. V., Ivanova, L. A., & Pokrovsky, V. V. (1993). Clinical significance of HIV DNA in polymorphonuclear neutrophils from patients with HIV infection. *JAIDS Journal of Acquired Immune Deficiency Syndromes*, 6(6), 587-591.
- Galati, D., & Bocchino, M. (2007). New insights on the perturbations of T cell cycle during HIV infection. *Current medicinal chemistry*, 14(18), 1920-1924.
- Gerlach, J. T., Diepolder, H. M., Zachoval, R., Gruener, N. H., Jung, M. C., Ulsenheimer, A., ...& Pape, G. R. (2003). Acute hepatitis C: high rate of both spontaneous and treatment-induced viral clearance. *Gastroenterology*, 125(1), 80-88.

- Glässner, A., Eisenhardt, M., Kokordelis, P., Krämer, B., Wolter, F., Nischalke, H. D., ...& Nattermann, J. (2013). Impaired CD4+ T cell stimulation of NK cell anti-fibrotic activity may contribute to accelerated liver fibrosis progression in HIV/HCV patients. *Journal of hepatology*, 59(3), 427-433.
- Gong, Z., Tang, J., Xiang, T., Zhang, L., Liao, Q., Liu, W., & Wang, Y. (2013). Association between regulated upon activation, normal T Cells expressed and secreted (RANTES)-28C/G polymorphism and susceptibility to HIV-1 infection: a meta-analysis. *PloS one*, 8(4), e60683.
- Gonzalez, E., Rovin, B. H., Sen, L., Cooke, G., Dhanda, R., Mummidi, S., ...& Walter, E. A. (2002). HIV-1 infection and AIDS dementia are influenced by a mutant MCP-1 allele linked to increased monocyte infiltration of tissues and MCP-1 levels. *Proceedings of the National Academy of Sciences*, 99(21), 13795-13800.
- Graham, C. S., Baden, L. R., Yu, E., Mrus, J. M., Carnie, J., Heeren, T., & Koziel, M. J. (2001). Influence of human immunodeficiency virus infection on the course of hepatitis C virus infection: a meta-analysis. *Clinical infectious diseases*, 33(4), 562-569.
- Grossman, Z., Meier-Schellersheim, M., Paul, W. E., & Picker, L. J. (2006). Pathogenesis of HIV infection: what the virus spares is as important as what it destroys. *Nature medicine*, 12(3), 289-295.
- Gruters, R. A., Terpstra, F. G., de Jong, R., Van Noesel, C. J., Van Lier, R. A., & Miedema, F. (1990). Selective loss of T cell functions in different stages of HIV infection Early loss of anti-CD3-induced T cell proliferation followed by decreased anti-CD3-induced cytotoxic T lymphocyte generation in AIDS-related complex and AIDS. *European journal of immunology*, 20(5), 1039-1044.

- Guadalupe, M., Reay, E., Sankaran, S., Prindiville, T., Flamm, J., McNeil, A., & Dandekar, S. (2003). Severe CD4⁺ T-cell depletion in gut lymphoid tissue during primary human immunodeficiency virus type 1 infection and substantial delay in restoration following highly active antiretroviral therapy. *Journal of virology*, 77(21), 11708-11717.
- Guidotti, L. G., & Chisari, F. V. (2001). Noncytolytic control of viral infections by the innate and adaptive immune response. *Annual review of immunology*, 19(1), 65-91.
- Harcourt, G., Gomperts, E., Donfield, S., & Klenerman, P. (2006). Diminished frequency of hepatitis C virus specific interferon γ secreting CD4⁺ T cells in human immunodeficiency virus/hepatitis C virus coinfecting patients. *Gut*, 55(10), 1484-1487.
- He, B., Qiao, X., Klasse, P. J., Chiu, A., Chadburn, A., Knowles, D. M., ...& Cerutti, A. (2006). HIV-1 envelope triggers polyclonal Ig class switch recombination through a CD40-independent mechanism involving BAFF and C-type lectin receptors. *The Journal of Immunology*, 176(7), 3931-3941.
- Hellier, S., Frodsham, A. J., Hennig, B. J., Klenerman, P., Knapp, S., Ramaley, P., ...& Thursz, M. (2003). Association of genetic variants of the chemokine receptor CCR5 and its ligands, RANTES and MCP-2, with outcome of HCV infection. *Hepatology*, 38(6), 1468-1476.
- Henry, D. H., & Hoxie, J. A. (2005). Hematological manifestations of AIDS. Hoffmann R, Benz EJ, Shattil SJ, Furie B, Cohen HJ, Silberstein LE, and others (eds). Hematology basic principles and practice, 4th edition. Philadelphia, Churchill Livingstone, 2, 585-612.

- Heydtmann, M., Hardie, D., Shields, P. L., Faint, J., Buckley, C. D., Campbell, J. J., ...& Adams, D. H. (2006). Detailed analysis of intrahepatic CD8 T cells in the normal and hepatitis C-infected liver reveals differences in specific populations of memory cells with distinct homing phenotypes. *The Journal of Immunology*, 177(1), 729-738.
- Heydtmann, M., Shields, P., McCaughan, G., & Adams, D. (2001). Cytokines and chemokines in the immune response to hepatitis C infection. *Current opinion in infectious diseases*, 14(3), 279-287.
- HIV, W. (2009). AIDS Programme. Rapid advice: antiretroviral therapy for HIV infection in adults and adolescents.
- Hizawa, N., Yamaguchi, E., Konno, S., Tanino, Y., Jinushi, E., & Nishimura, M. (2002). A functional polymorphism in the RANTES gene promoter is associated with the development of late-onset asthma. *American journal of respiratory and critical care medicine*, 166(5), 686-690.
- Issekutz, T. B. (1993). Dual inhibition of VLA-4 and LFA-1 maximally inhibits cutaneous delayed-type hypersensitivity-induced inflammation. *The American journal of pathology*, 143(5), 1286.
- Kahn, J. O., & Walker, B. D. (1998). Acute human immunodeficiency virus type 1 infection. *New England Journal of Medicine*, 339(1), 33-39.
- Kellerman, S. E., Hanson, D. L., McNaghten, A. D., & Fleming, P. L. (2003). Prevalence of chronic hepatitis B and incidence of acute hepatitis B infection in human immunodeficiency virus-infected subjects. *Journal of Infectious Diseases*, 188(4), 571-577.

- Koziel, M. J. (1998). Cytokines in viral hepatitis. In *Seminars in liver disease* 19(2), 157-169.
- Landrum, M. L., Fieberg, A. M., Chun, H. M., Crum-Cianflone, N. F., Marconi, V. C., Weintrob, A. C., ...& Agan, B. K. (2010). The effect of human immunodeficiency virus on hepatitis B virus serologic status in co-infected adults. *PLoS One*, 5(1), e8687.
- Lesi, O. A., Kehinde, M. O., Oguh, D. N., & Amira, C. O. (2007). Hepatitis B and C virus infection in Nigerian patients with HIV/AIDS. *The Nigerian postgraduate medical journal*, 14(2), 129-133.
- Liu, H., Chao, D., Nakayama, E. E., Taguchi, H., Goto, M., Xin, X., ...& Juji, T. (1999). Polymorphism in RANTES chemokine promoter affects HIV-1 disease progression. *Proceedings of the National Academy of Sciences*, 96(8), 4581-4585.
- Lloyd, A. R., Jagger, E., Post, J. J., Crooks, L. A., Rawlinson, W. D., Hahn, Y. S., & Ffrench, R. A. (2007). Host and viral factors in the immunopathogenesis of primary hepatitis C virus infection. *Immunology and cell biology*, 85(1), 24-32.
- Macatonia, S. E., Lau, R., Patterson, S., Pinching, A. J., & Knight, S. C. (1990). Dendritic cell infection, depletion and dysfunction in HIV-infected individuals. *Immunology*, 71(1), 38.
- Marone, G., Florio, G., Petraroli, A., Triggiani, M., & De Paulis, A. (2001). Role of human FcεRI+ cells in HIV-1 infection. *Immunological reviews*, 179(1), 128-138.

- Mastroianni, C. M., Lichtner, M., Mascia, C., Zuccalà, P., & Vullo, V. (2014).Molecular mechanisms of liver fibrosis in HIV/HCV coinfection. *International journal of molecular sciences*, 15(6), 9184-9208.
- Mathews, G, Bhagani, S. (2003).The epidemiology and natural history of HIV/HBV and HCV co-infections.*J HIV Ther.*8, 77–84.
- McDermott, D. H., Beecroft, M. J., Kleeberger, C. A., Al-Sharif, F. M., Ollier, W. E., Zimmerman, P. A., ... & Murphy, P. M. (2000). Chemokine RANTES promoter polymorphism affects risk of both HIV infection and disease progression in the Multicenter AIDS Cohort Study. *Aids*, 14(17), 2671-2678
- McKiernan, S. M., Hagan, R., Curry, M., McDonald, G. S., Kelly, A., Nolan, N., ...& Kelleher, D. (2004). Distinct MHC class I and II alleles are associated with hepatitis C viral clearance, originating from a single source. *Hepatology*, 40(1), 108-114.
- Mehal, W. Z., & Friedman, S. L. (2007).The role of inflammation and immunity in the pathogenesis of liver fibrosis.In *Liver immunology* (pp. 111-121). NJ: Humana Press.
- Mehta, S. H., Cox, A., Hoover, D. R., Wang, X. H., Mao, Q., Ray, S., ...& Thomas, D. L. (2002). Protection against persistence of hepatitis C. *The Lancet*, 359(9316), 1478-1483.
- Meltzer, M. S., Nakamura, M., Hansen, B. D., Turpin, J. A., Kalter, D. C., & Gendelman, H. E. (1990).Macrophages as susceptible targets for HIV infection, persistent viral reservoirs in tissue, and key immunoregulatory cells that control levels of virus replication and extent of disease. *AIDS research and human retroviruses*, 6(8), 967-971.

- Moir, S., Malaspina, A., Li, Y., Chun, T. W., Lowe, T., Adelsberger, J., ...& Mican, J. A. M. (2000). B cells of HIV-1–infected patients bind virions through CD21–complement interactions and transmit infectious virus to activated T cells. *The Journal of experimental medicine*, 192(5), 637-646.
- Moir, S., Malaspina, A., Ogwaro, K. M., Donoghue, E. T., Hallahan, C. W., Ehler, L. A., ...& Baseler, M. (2001). HIV-1 induces phenotypic and functional perturbations of B cells in chronically infected individuals. *Proceedings of the National Academy of Sciences*, 98(18), 10362-10367
- Moir, S., Malaspina, A., Pickeral, O. K., Donoghue, E. T., Vasquez, J., Miller, N. J., ...& Kottlil, S. (2004). Decreased survival of B cells of HIV-viremic patients mediated by altered expression of receptors of the TNF superfamily. *The Journal of experimental medicine*, 200(5), 587-600.
- Murphy, P. M. (1996). Chemokine receptors: structure, function and role in microbial pathogenesis. *Cytokine & growth factor reviews*, 7(1), 47-64.
- Murphy, P. M., Lane, H. C., Fauci, A. S., & Gallin, J. I. (1988). Impairment of neutrophil bactericidal capacity in patients with AIDS. *The Journal of infectious diseases*, 158(3), 627-630.
- National Collaborating Centre for Infectious Diseases (NCCID), (2008). Retrieved from http://www.nccid.ca/en/files/Evidence_reviews/ART_as_prevention_Eng.pdf.
- Nelson, J., Reynolds-Kohler, C., Margaretten, W., Wiley, C., Reese, C., & Levy, J. (1988). Human immunodeficiency virus detected in bowel epithelium from patients with gastrointestinal symptoms. *The Lancet*, 331(8580), 259-262.

- Nelson, P. J., Kim, H. T., Manning, W. C., Goralski, T. J., & Krensky, A. M. (1993). Genomic organization and transcriptional regulation of the RANTES chemokine gene. *The Journal of Immunology*, *151*(5), 2601-2612.
- Nicholson, K. M., & Anderson, N. G. (2002). The protein kinase B/Akt signalling pathway in human malignancy. *Cellular signalling*, *14*(5), 381-395
- Nyirenda, M., Beadsworth, M. B. J., Stephany, P., Hart, C. A., Hart, I. J., Munthali, C., ...& Zijlstra, E. E. (2008). Prevalence of infection with hepatitis B and C virus and coinfection with HIV in medical inpatients in Malawi. *Journal of Infection*, *57*(1), 72-77.
- Olufemi A, Emmanuel A, Zaccheus A, Ibrahim W, Funmilayo E, Patience A. (2009) Hepatitis B and C virus co-infection in Nigerian patients with HIV infection. *Journal of Infectious DevCtries*.*10*(5), 369–375.
- Pan, Z. Z., Parkyn, L., Ray, A., & Ray, P. (2000). Inducible lung-specific expression of RANTES: preferential recruitment of neutrophils. *American Journal of Physiology-Lung Cellular and Molecular Physiology*, *279*(4), L658-L666.
- Perrillo, R. P. (2001). Acute flares in chronic hepatitis B: the natural and unnatural history of an immunologically mediated liver disease. *Gastroenterology*, *120*(4), 1009-1022.
- Peterlin, B. M., & Trono, D. (2003). Hide, shield and strike back: how HIV-infected cells avoid immune eradication. *Nature Reviews Immunology*, *3*(2), 97-107.
- Pickering, L.K., Baker, C.J., Kimberlin, D.W. & Long, S.S. (2009). Human Immunodeficiency Virus Infection. Report of the Committee on Infectious Diseases. (28th ed). Elk Grove, IL: American Academy of Pediatrics.

- Piguet V, Steinman RM. (2007)The interaction of HIV with dendritic cells: outcomes and pathways. *Trends in Immunology*. 28(11), 503–510.
- Piroth, L., Sène, D., Pol, S., Goderel, I., Lacombe, K., Martha, B., ...& Gervais, A. (2007). Epidemiology, diagnosis and treatment of chronic hepatitis B in HIV-infected patients (EPIB 2005 STUDY). *Aids*, 21(10), 1323-1331.
- Pomerantz, R. J., Kuritzkes, D. R., de la Monte, S. M., Rota, T. R., Baker, A. S., Albert, D., ... & Hirsch, M. S. (1987). Infection of the retina by human immunodeficiency virus type I. *New England Journal of Medicine*, 317(26), 1643-1647.
- Promrat, K., McDermott, D. H., Gonzalez, C. M., Kleiner, D. E., Koziol, D. E., Lessie, M., ...& Park, Y. (2003). Associations of chemokine system polymorphisms with clinical outcomes and treatment responses of chronic hepatitis C. *Gastroenterology*, 124(2), 352-360.
- Rehermann, B. (2009). Hepatitis C virus versus innate and adaptive immune responses: a tale of coevolution and coexistence. *The Journal of clinical investigation*, 119(7), 1745-1754.
- Rehermann, B., & Nascimbeni, M. (2005). Immunology of hepatitis B virus and hepatitis C virus infection. *Nature Reviews Immunology*, 5(3), 215-229.
- Rehermann, B., & Nascimbeni, M. (2005). Immunology of hepatitis B virus and hepatitis C virus infection. *Nature Reviews Immunology*, 5(3), 215-229.
- Revill, P. A., Littlejohn, M., Ayres, A., Yuen, L., Colledge, D., Bartholomeusz, A., ...& Thio, C. L. (2007). Identification of a novel hepatitis B virus precore/core

- deletion mutant in HIV/hepatitis B virus co-infected individuals. *Aids*, 21(13), 1701-1710.
- Schall, T. J., Bacon, K., Toy, K. J., & Goeddel, D. V. (1990). Selective attraction of monocytes and T lymphocytes of the memory phenotype by cytokine RANTES. *Nature*, 347(6294), 669-671.
- Shields, P. L., Morland, C. M., Salmon, M., Qin, S., Hubscher, S. G., & Adams, D. H. (1999). Chemokine and chemokine receptor interactions provide a mechanism for selective T cell recruitment to specific liver compartments within hepatitis C-infected liver. *The Journal of Immunology*, 163(11), 6236-6243.
- Simon, O. O., Haruna A. B2., Marycelin, M. B1, Grace, I. A. & Alhaji, B.(2014). The Effect of Co-infection of HIV and Hepatotropic Viruses on Selected Biochemical and Haematological Markers of Patients in Northeastern Nigeria. *International Journal of tropical diseaseand Health* 4(5), 568-581.
- Simpore, J., Savadogo, A., Ilboudo, D., Nadambega, M. C., Esposito, M., Yara, J., ...& Musumeci, S. (2006). Toxoplasma gondii, HCV, and HBV seroprevalence and co-infection among HIV-positive and-negative pregnant women in Burkina Faso. *Journal of medical virology*, 78(6), 730-733.
- Skiest, D. J., & Keiser, P. (1997).Clinical significance of eosinophilia in HIV-infected individuals. *The American journal of medicine*, 102(5), 449-453.
- Sonza, S., Kiernan, R. E., Maerz, A. L., Deacon, N. J., McPhee, D. A., & Crowe, S. M. (1994). Accumulation of unintegrated circular viral DNA in monocytes and growth-arrested T cells following infection with HIV-1. *Journal of leukocyte biology*, 56(3), 289-293.

- Sonza, S., Maerz, A., Deacon, N., Meanger, J., Mills, J., & Crowe, S. (1996). Human immunodeficiency virus type 1 replication is blocked prior to reverse transcription and integration in freshly isolated peripheral blood monocytes. *Journal of virology*, 70(6), 3863-3869.
- Sousa, A. E., Carneiro, J., Meier-Schellersheim, M., Grossman, Z., & Victorino, R. M. (2002). CD4 T cell depletion is linked directly to immune activation in the pathogenesis of HIV-1 and HIV-2 but only indirectly to the viral load. *The Journal of Immunology*, 169(6), 3400-3406.
- Stephen, J. G., Alvaro Muñoz, J. S. Chmiel, A. D. Donnenberg, L. M., Kirstein, R. D, & Joseph, B. (1998). Margolic Identification of inflections in T-cell counts among HIV-1-infected individuals and relationship with progression to clinical. *AIDS Proc. Natl. Acad. Sci.* 95, 10848–10853.
- Sulkowski, M. S., & Thomas, D. L. (2003).Hepatitis C in the HIV-infected person. *Annals of internal medicine*, 138(3), 197-207.
- Testa, R., Testa, E., Giannini, E., Borro, P., Milazzo, S., Isola, L., ...& Risso, D. (2006). Noninvasive ratio indexes to evaluate fibrosis staging in chronic hepatitis C: role of platelet count/spleen diameter ratio index. *Journal of internal medicine*, 260(2), 142-150.
- Thimme, R., Binder, M., & Bartenschlager, R. (2012).Failure of innate and adaptive immune responses in controlling hepatitis C virus infection. *FEMS microbiology reviews*, 36(3), 663-683.
- Thio, C. L., Seaberg, E. C., Skolasky, R., Phair, J., Visscher, B., Muñoz, A., & Thomas, D. L. (2002).HIV-1, hepatitis B virus, and risk of liver-related mortality in the Multicenter Cohort Study (MACS). *The Lancet*, 360(9349), 1921-1926.

- Tolan, D. J., Davies, M. H., & Millson, C. E. (2001). Fibrosing cholestatic hepatitis after liver transplantation in a patient with hepatitis C and HIV infection. *New England Journal of Medicine*, 345(24), 1781-1781.
- UN AIDS, (2010). AIDS Epidemic. Retrieved from <http://www.unaids.org/en/dataanalysis/epidemiology/>
- Valdez, H., & Lederman, M. M. (1996). Cytokines and cytokine therapies in HIV infection. *AIDS clinical review*, 187-228.
- Veiga, A. P. R., Casseb, J., & Duarte, A. J. (2006). Humoral response to hepatitis B vaccination and its relationship with T CD45RA+ (naive) and CD45RO+ (memory) subsets in HIV-1-infected subjects. *Vaccine*, 24(49), 7124-7128.
- Vlahakis, S. R., Villasis-Keever, A., Gomez, T. S., Bren, G. D., & Paya, C. V. (2003). Human immunodeficiency virus-induced apoptosis of human hepatocytes via CXCR4. *Journal of Infectious Diseases*, 188(10), 1455-1460.
- Vrisekoop, N., van Gent, R., de Boer, A. B., Otto, S. A., Borleffs, J. C., Steingrover, R., ... & Vulto, I. (2008). Restoration of the CD4 T cell compartment after long-term highly active antiretroviral therapy without phenotypical signs of accelerated immunological aging. *The Journal of Immunology*, 181(2), 1573-1581.
- Weiss, R.A., Dalgleish, A.G., Loveday, C., & Pillay, D. (2004). Human Immunodeficiency Viruses. In: Zuckerman, A.J, Banatvala, J.E, Pattison, J.R, Griffiths, P.D, Schoub, B.D. (eds). *Principles and Practice of Clinical Virology*. (5thed). Chichester: John Wiley & Sons Ltd.
- Weller, P. F., Marshall, W. L., Lucey, D. R., Rand, T. H., Dvorak, A. M., & Finberg, R. W. (1995). Infection, apoptosis, and killing of mature human eosinophils by

human immunodeficiency virus-1. *American journal of respiratory cell and molecular biology*, 13(5), 610-620.

WHO, (2009). Rapid advice: antiretroviral therapy for HIV infection in adults and adolescents. Geneva: WHO.

Wondimeneh, Y., Alem, M., Asfaw, F., & Belyhun, Y. (2013). HBV and HCV seroprevalence and their correlation with CD4 cells and liver enzymes among HIV positive individuals at University of Gondar Teaching Hospital, Northwest Ethiopia. *Virology journal*, 10(1), 1.

World Health Organization, (2011). Hepatitis C. Retrieved from www.who.int/mediacentre/factsheets/fs164/en/.

Yang, H. I., Yeh, S. H., Chen, P. J., Iloeje, U. H., Jen, C. L., Su, J., ... & Liaw, Y. F. (2008). Associations between hepatitis B virus genotype and mutants and the risk of hepatocellular carcinoma. *Journal of the National Cancer Institute*, 100(16), 1134-1143.

Yaron, R. & Liang, T. J. (2009). *J Virol.* 83(15), 7366–7374.

Yoshie, O., Imai, T., & Nomiyama, H. (2001). Chemokines in immunity. *Advances in immunology*, 78, 57-110.

Yuen, M. F., Wong, D. K. H., Sablon, E., Tse, E., Ng, I. O. L., Yuan, H. J., ... & Condreay, L. D. (2004). HBsAg seroclearance in chronic hepatitis B in the Chinese: virological, histological, and clinical aspects. *Hepatology*, 39(6), 1694-1701.

- Zhang, D., Shankar, P., Xu, Z., Harnisch, B., Chen, G., Lange, C., ...& Lieberman, J. (2003). Most antiviral CD8 T cells during chronic viral infection do not express high levels of perforin and are not directly cytotoxic. *Blood*, *101*(1), 226-235.
- Zhang, L., Yu, W., He, T., Yu, J., Caffrey, R. E., Dalmasso, E. A., ...& Zhang, W. (2002). Contribution of human α -defensin 1, 2, and 3 to the anti-HIV-1 activity of CD8 antiviral factor. *Science*, *298*(5595), 995-1000.
- Zhu, T., Muthui, D., Holte, S., Nickle, D., Feng, F., Brodie, S., ...& Corey, L. (2002). Evidence for human immunodeficiency virus type 1 replication in vivo in CD14+ monocytes and its potential role as a source of virus in patients on highly active antiretroviral therapy. *Journal of virology*, *76*(2), 707-716.

APPENDICES

Appendix 1 : EtBr (ethidium bromide 5 mg / ml)

Ethidium Bromide 500 milligram (mg)

DdH₂O to 100 millilitre (ml)

Total volume 100 millilitre (ml)

Add 5µl/100ml EtBr stock

Appendix 2: Distribution of leukocytes

Above normal level distribution of leukocytes

	HIV-1 (%)	infection	HIV/HBV coinfection (%)	HIV/HCV coinfection (%)
CD4	0		0	0
CD3	0		0	5
Absolute lymphocytes	90		90	85
Neutrophils	5		0	0
Monocytes	8		22	20
Eosinophils	1		11	0
Basophils	0		0	0
Platelets	0		0	0

Below normal range distribution of leukocytes

	HIV-1 infection (%)	HIV/HBV coinfection (%)	HIV/HCV coinfection (%)
CD4	63	78	60
CD3	19	0	0
Absolute lymphocytes	0	0	0
Neutrophils	91	78	90
Monocytes	17	0	0
Eosinophils	40	56	40
Basophils	57	78	70
Platelets	30	22	30

Appendix 3 Comparison of CD4 Ranges in HIV Negative Individuals Comparison of CD4 Ranges in HIV Negative Individuals Ordered by Mean CD4 Count, CD4 Count for the different geographical regions in Kenya

Region	Lymphocyte subset						
		CD3 count	CD3%	CD4 count	CD4%	CD8 count	CD8%
Nairobi	Mean ± SD	1841 ± 486c	69 ± 6a	1046 ± 283c	39 ± 6a	717 ± 260c	26 ± 5c
	Median	1824	69	1007	39	691	26
	Range	908-2661	55-79	517-1506	27-48	266-1165	16-35
Eastern	Mean ± SD	1728 ± 642b	64 ± 7a	949 ± 209b	37 ± 7b	650 ± 329ab	24 ± 6ab
	Median	1617	64	959	37	529	22
	Range	813-2512	47-77	512-1320	21-50	213-1083	11-34
Rift valley	Mean ± SD	1876 ± 883d	67 ± 8b	1029 ± 559ab	37 ± 7c	752 ± 421d	27 ± 8b
	Median	1666	68	902	36	640	26
	Range	660-3074	50-80	345-1703	23-47	217-1315	13-39
Lake Victoria	Mean ± SD	1195 ± 449abcd	66 ± 7c	690 ± 263abc	38 ± 6d	454 ± 231acd	25 ± 7d
	Median	1137	67	630	38	401	24
	Range	471-1886	50-77	275-1081	26-47	135-791	12-36
Coast	Mean ± SD	1617 ± 574a	66 ± 7d	881 ± 333a	36 ± 7a	675 ± 289a	28 ± 6a
	Median	1502	67	854	36	602	28
	Range	572-2708	51-77	281-1540	22-47	210-1179	16-37

Appendices 4: A memorandum for understanding between The Clinton foundation HIV-1/AIDS Initiative and Kenya Medical Research Institute(KEMRI), NAIROBI for HIV testing and monitoring CD4 in HIVinfected persons.

**MEMORANDUM OF UNDERSTANDING
BETWEEN
The Clinton Foundation HIV/AIDS Initiative
AND**

**Kenya Medical Research Institute (KEMRI), NAIROBI
For HIV Testing and Monitoring Project in Kenya**

This statement represents an agreement between the Clinton Foundation HIV/AIDS Initiative, herein referred to as CHAI, and the Kenya Medical Research Institute, herein referred to as KEMRI, regarding respective institutional roles and responsibilities in undertaking HIV Testing and Monitoring project. The HIV Testing and Monitoring Project includes but is not limited to Early Infant Testing of HIV by DNA PCR, CD4 testing in adults and children, and HIV drug resistance testing. For some of these activities, substantive protocols have already been developed and submitted to KEMRI for approval. New protocols will be developed and submitted whenever necessary.

INSTITUTIONAL ROLES:

1. CHAI has overall responsibility for coordinating all logistics associated with the HIV Testing and Monitoring.
2. KEMRI is responsible for conducting laboratory testing and monitoring of HIV.
3. KEMRI and CHAI will work together to build capacity in resource mobilization, in setting up and effectively managing resources, and in identifying logistics, human and financial resources needed to carry out the project efficiently and effectively.
4. KEMRI will be responsible for compiling annual and end of project reports for CHAI.
5. KEMRI will prepare a report on this project at the end of every reporting period (in July 2008, 2009 and 2010).
6. Collaboration between CHAI and KEMRI on matters relating to the HIV Testing and Monitoring project shall be governed by this MOU between the parties involved in such collaboration.
7. The two Institutions may amend the terms of this Memorandum of Understanding in writing provided that such an amendment is supported by four collaborators (2 from each side).

PROJECT GOVERNANCE:

8. A Project Management Board (PMB) comprising of the Heads of each institution, 2 CHAI collaborators, 2 KEMRI collaborators and the Project Coordinator will be set up. The role of the PMB will be to provide strategic leadership and direction to the project, and to resolve disputes. The PMB will meet once every quarter.

9. The day to day running of the entire project will be done by the KEMRI project coordinator and the designated counterpart from CHAI.
10. Project activities for each protocol will be managed by the principal investigators of the individual projects, who will report to the project coordinator.
11. The collaborating team composed of all the investigators in this project will have responsibility for:
 - Discussing field problems as they arise, including disputes that may arise with local stakeholders or issues that are unanticipated by the design of the project;
 - Reviewing and discussing progress by partners in maintaining commitments to components of the project.
 - Reviewing requests for project resources, such as data, by external agencies or individuals.
 - Planning dissemination project, research utilization mechanisms, and other components of the program designed to convert lessons learned into policy and large-scale action.
 - Field operations will be carried out jointly to avoid any misunderstandings that may arise out of any disjointed operations.

PROJECT FUNDING AND FINANCES

12. Both KEMRI and CHAI will raise funds to sustain the project and to support other related collaborative projects.

PROJECT RESOURCES

13. *Data.* Substantial research outputs will emerge from this project. Experimental results will be collected by KEMRI, who will provide reports to CHAI regularly. CHAI will be provided with data access on request. Participants in the project agree that data will not be released to external parties without prior concurrence of the Project Management Board.
14. *Reports.* Partners have obligations to donors, and to Board mandated annual reports, and other conventional institutional communication mechanisms. All such reports will be shared with other partners.

INTELLECTUAL PROPERTY AND CONFIDENTIALITY

15. Any research project must adhere to international and Kenyan ethical guidelines regarding human subjects.
16. CHAI and KEMRI agree to undertake periodic reviews of the program and the current agreement to strategize on subsequent project and ensure that the program is beneficial and fair to both parties.

17. The parties shall not use, release, share or give access to information and resources, especially data sets, internal memos, and other documents or reports, that they may have had access to prior to, during, and after the execution of the agreement, without due protection of the given information or resources and the express written consent of the other party. This provision does not hold if the concerned party can prove that:
 - a) it was lawfully in possession of the information or resources before the signature of the present agreement;
 - b) it lawfully acquired the information or resources by a third party;
 - c) the information or resources were already published or disseminated;
 - d) The information or resources had been placed in the public domain.
18. It is agreed that the present Article cannot prevent the collaborators from reporting annually on their project, or in case of proprietary or confidential information, to report confidentially to their Chief Executive, in as much as the report does not disclose information in the sense of the intellectual property law.
19. The present intellectual property and confidentiality agreement will remain valid until the information loses its proprietary or confidential nature.